

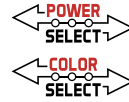

SENTINEL  
WALL MOUNT CYLINDER

FormFIT  
optic swap



# KT-CYLEDXXPS-XA-WDI-OSG-8CSB-VDIM-X

## DIRECT/INDIRECT WALL MOUNT CYLINDER

### DESCRIPTION

Wall Mount Cylinder | Power Select | Color Select | Direct and/or Indirect Lighting | Interchangeable Optics | 120-277V Input | Multiple Finish Options

### APPLICATION

Functional and decorative up direct/indirect outdoor wall cylinder for entryway, façade, awning, and wall washer applications



RoHS Compliant

10 YEAR LIMITED WARRANTY



### PRODUCT FEATURES

- Keystone Power Select technology (see *PRODUCT SPECIFICATIONS for details*)
- Keystone Color Select technology (3000/4000/5000K)
- Screw-on cap and three sets of reflectors for easy optic swap (40° installed, 25° and 60° included)
- Easy-to-access dip switch for direct, indirect, or full illumination
- Compatible with slip-on shells in various finishes
- Built-in dusk-to-dawn photocell
- Die-cast aluminum housing in a modern aesthetic
- UL Certified, IP65 rated
- Ambient operating temperature: -40°C/-40°F - 45°C/113°F
- LED chip lifetime: L70 > 100,000 hrs @ 25°C/77°F ambient
- Rated life: 50,000 hours
- Meets FCC Part 15, Part B, Class A standards for conducted and radiated emissions



3" Cylinder Fixture  
Bronze



3" Cylinder Fixture  
White



3" Cylinder Fixture  
Black



4" Cylinder Fixture  
Bronze



4" Cylinder Fixture  
White



4" Cylinder Fixture  
Black



6" Cylinder Fixture  
Bronze



6" Cylinder Fixture  
White



6" Cylinder Fixture  
Black

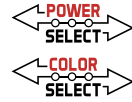

# KT-CYLEDXXPS-XA-WDI-OSG-8CSB-VDIM-X

## DIRECT/INDIRECT WALL MOUNT CYLINDER

**PRODUCT SPECIFICATIONS (SETTING: FULL)**

Catalog Number	Selectable Wattage	Selectable CCT	Lumens	Efficacy	Input Voltage	Dimming	CRI	Optics	Light Direction Control
KT-CYLED36PS-6A-WDI-OSG-8CSB-VDIM KT-CYLED36PS-6A-WDI-OSG-8CSB-VDIM-W KT-CYLED36PS-6A-WDI-OSG-8CSB-VDIM-B	36W	3000K	3,050	85 lm/W	120-277V	0-10V	> 80	40° lens installed 25° and 60° included	
		4000K	3,100	86 lm/W					
		5000K	3,200	89 lm/W					
	28W	3000K	2,500	89 lm/W					
		4000K	2,700	96 lm/W					
		5000K	2,750	98 lm/W					
	21W	3000K	2,010	96 lm/W					
		4000K	2,150	102 lm/W					
		5000K	2,210	105 lm/W					
KT-CYLED20PS-4A-WDI-OSG-8CSB-VDIM KT-CYLED20PS-4A-WDI-OSG-8CSB-VDIM-W KT-CYLED20PS-4A-WDI-OSG-8CSB-VDIM-B	20W	3000K	1,840	92 lm/W	120-277V	0-10V	> 80	40° lens installed 25° and 60° included	
		4000K	1,950	98 lm/W					
		5000K	2,050	103 lm/W					
	16W	3000K	1,500	94 lm/W					
		4000K	1,570	98 lm/W					
		5000K	1,650	103 lm/W					
	12W	3000K	1,160	97 lm/W					
		4000K	1,220	102 lm/W					
		5000K	1,290	108 lm/W					
KT-CYLED10PS-3A-WDI-OSG-8CSB-VDIM KT-CYLED10PS-3A-WDI-OSG-8CSB-VDIM-W KT-CYLED10PS-3A-WDI-OSG-8CSB-VDIM-B	10W	3000K	965	97 lm/W	120-277V	0-10V	> 80	40° lens installed 25° and 60° included	
		4000K	1,000	100 lm/W					
		5000K	1,050	105 lm/W					
	8W	3000K	785	98 lm/W					
		4000K	810	101 lm/W					
		5000K	840	105 lm/W					
	6W	3000K	605	101 lm/W					
		4000K	620	103 lm/W					
		5000K	600	100 lm/W					

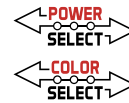

(Product Specifications continued on next page)



# KT-CYLEDXXPS-XA-WDI-OSG-8CSB-VDIM-X

## DIRECT/INDIRECT WALL MOUNT CYLINDER

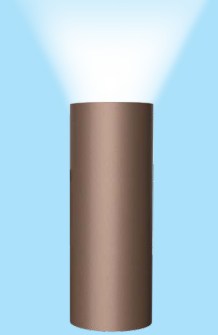
**PRODUCT SPECIFICATIONS** (SETTING: *DIRECT OR INDIRECT*)

Catalog Number	Selectable Wattage	Selectable CCT	Lumens	Efficacy	Input Voltage	Dimming	CRI	Optics	Light Direction Control
KT-CYLED36PS-6A-WDI-OSG-8CSB-VDIM KT-CYLED36PS-6A-WDI-OSG-8CSB-VDIM-W KT-CYLED36PS-6A-WDI-OSG-8CSB-VDIM-B	18W	3000K	1,525	85 lm/W	120-277V	0-10V	> 80	40° lens installed 25° and 60° included	 Indirect
		4000K	1,550	86 lm/W					
		5000K	1,600	89 lm/W					
	14W	3000K	1,250	89 lm/W					
		4000K	1,350	96 lm/W					
		5000K	1,375	98 lm/W					
	10.5W	3000K	1,005	96 lm/W					
		4000K	1,075	102 lm/W					
		5000K	1,105	105 lm/W					
KT-CYLED20PS-4A-WDI-OSG-8CSB-VDIM KT-CYLED20PS-4A-WDI-OSG-8CSB-VDIM-W KT-CYLED20PS-4A-WDI-OSG-8CSB-VDIM-B	10W	3000K	920	92 lm/W	120-277V	0-10V	> 80	40° lens installed 25° and 60° included	 Direct
		4000K	975	98 lm/W					
		5000K	1,025	103 lm/W					
	8W	3000K	750	94 lm/W					
		4000K	785	98 lm/W					
		5000K	825	103 lm/W					
	6W	3000K	580	97 lm/W					
		4000K	610	102 lm/W					
		5000K	645	108 lm/W					
KT-CYLED10PS-3A-WDI-OSG-8CSB-VDIM KT-CYLED10PS-3A-WDI-OSG-8CSB-VDIM-W KT-CYLED10PS-3A-WDI-OSG-8CSB-VDIM-B	5W	3000K	483	97 lm/W	120-277V	0-10V	> 80	40° lens installed 25° and 60° included	 Direct
		4000K	500	100 lm/W					
		5000K	525	105 lm/W					
	4W	3000K	393	98 lm/W					
		4000K	405	101 lm/W					
		5000K	420	105 lm/W					
	3W	3000K	303	101 lm/W					
		4000K	310	103 lm/W					
		5000K	300	100 lm/W					

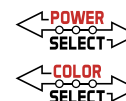

# KT-CYLEDXXPS-XA-WDI-OSG-8CSB-VDIM-X

## DIRECT/INDIRECT WALL MOUNT CYLINDER

### PHOTOMETRIC SPECIFICATIONS KT-CYLED20PS-4A-WDI-OSG-8CSB-VDIM (25° REFLECTOR WITH FULL ILLUMINATION)

ISOCANDELA PLOT

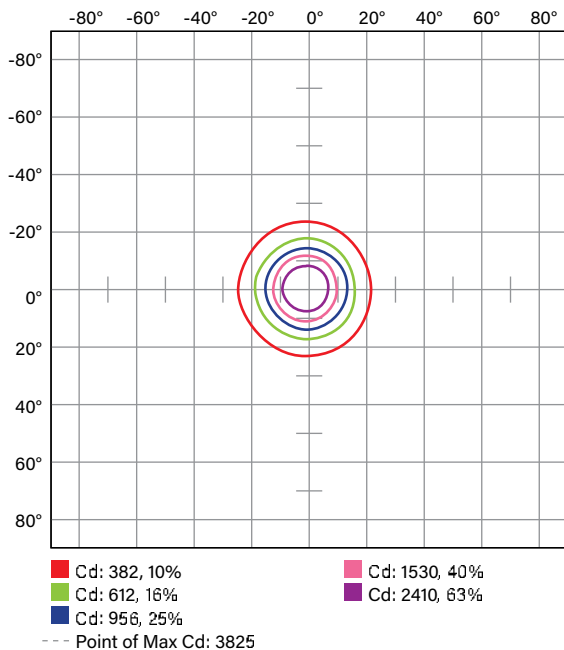

LUMINOUS INTENSITY DISTRIBUTION

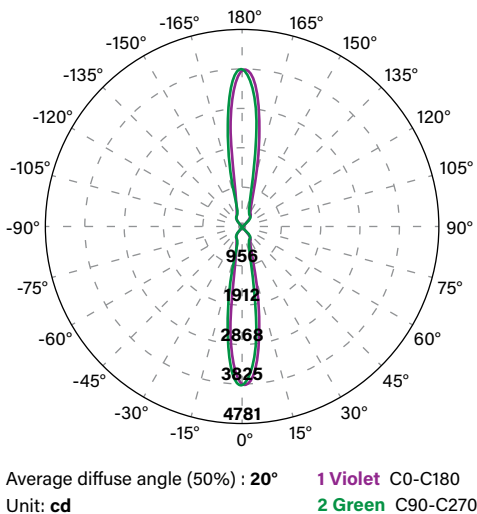

FLUX DISTRIBUTION

Zone	Lumens	% Luminaire
<b>Forward Light</b>	471 lm	24.8%
0°-30°	331 lm	17.4%
30°-60°	119 lm	6.3%
60°-80°	14 lm	0.7%
80°-90°	7 lm	0.4%
<b>Back Light</b>	488 lm	25.7%
0°-30°	346 lm	18.2%
30°-60°	122 lm	6.4%
60°-80°	14 lm	0.7%
80°-90°	6 lm	0.3%
<b>Up Light</b>	939 lm	49.5%
90°-100°	10 lm	0.5%
100°-180°	929 lm	48.9%

  

BUG* Rating	
<b>Asymmetrical Luminaire Types</b>	
Type I, II, III, IV	B1 U4 G0
<b>Quadrilateral Symmetrical Luminaire Types</b>	
Type V, Area Light	B1 U4 G0

\* Backlight, Uplight, Glare

### PHOTOMETRIC SPECIFICATIONS KT-CYLED20PS-4A-WDI-OSG-8CSB-VDIM (40° REFLECTOR WITH FULL ILLUMINATION)

ISOCANDELA PLOT

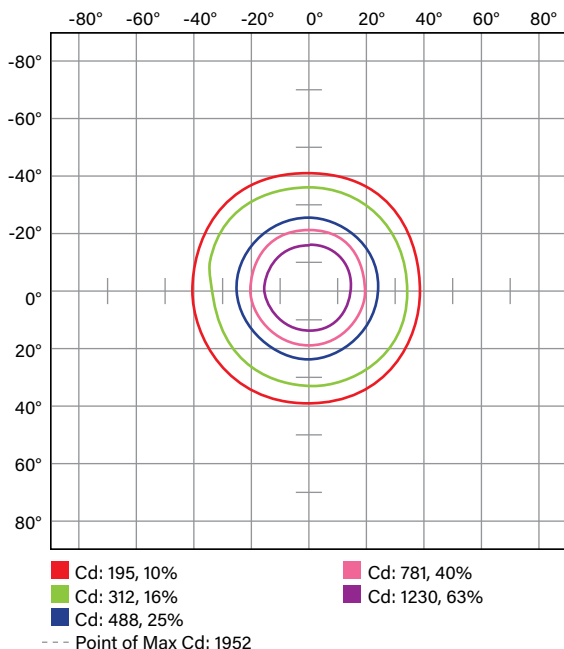

LUMINOUS INTENSITY DISTRIBUTION

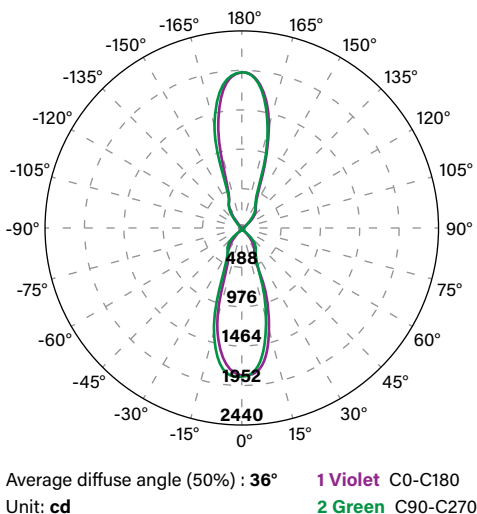

FLUX DISTRIBUTION

Zone	Lumens	% Luminaire
<b>Forward Light</b>	459 lm	23.6%
0°-30°	343 lm	17.6%
30°-60°	111 lm	5.7%
60°-80°	4 lm	0.2%
80°-90°	1 lm	0.1%
<b>Back Light</b>	521 lm	26.8%
0°-30°	384 lm	19.7%
30°-60°	132 lm	6.8%
60°-80°	4 lm	0.2%
80°-90°	1 lm	0.1%
<b>Up Light</b>	967 lm	49.7%
90°-100°	2 lm	0.1%
100°-180°	965 lm	49.6%

BUG* Rating	
<b>Asymmetrical Luminaire Types</b>	
Type I, II, III, IV	B1 U4 G0
<b>Quadrilateral Symmetrical Luminaire Types</b>	
Type V, Area Light	B1 U4 G0

\* Backlight, Uplight, Glare

(Photometric Specifications continued on next page)

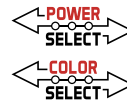

# KT-CYLEDXXPS-XA-WDI-OSG-8CSB-VDIM-X

## DIRECT/INDIRECT WALL MOUNT CYLINDER

### PHOTOMETRIC SPECIFICATIONS KT-CYLED20PS-4A-WDI-OSG-8CSB-VDIM (60° REFLECTOR WITH FULL ILLUMINATION)

#### ISOCANDELA PLOT

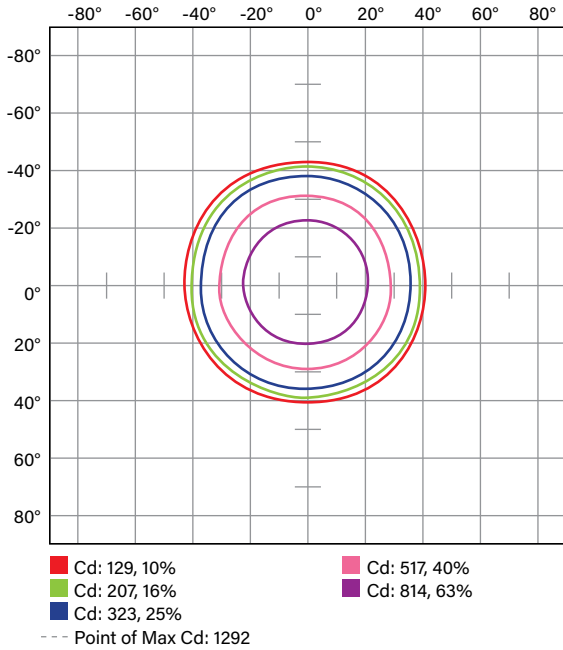

#### LUMINOUS INTENSITY DISTRIBUTION

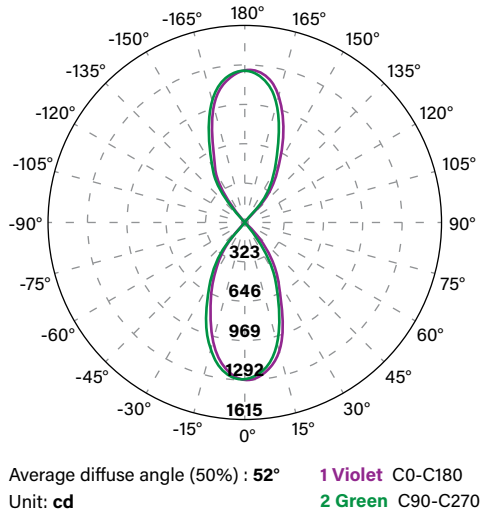

#### FLUX DISTRIBUTION

Zone	Lumens	% Luminaire
<b>Forward Light</b>	483 lm	24.2%
0°-30°	352 lm	17.6%
30°-60°	129 lm	6.5%
60°-80°	2 lm	0.1%
80°-90°	0 lm	0.0%
<b>Back Light</b>	523 lm	26.2%
0°-30°	369 lm	18.5%
30°-60°	152 lm	7.6%
60°-80°	2 lm	0.1%
80°-90°	0 lm	0.0%
<b>Up Light</b>	991 lm	49.6%
90°-100°	0 lm	0.0%
100°-180°	991 lm	49.6%

BUG* Rating	
<b>Asymmetrical Luminaire Types</b>	
Type I, II, III, IV	B1 U4 G0
<b>Quadrilateral Symmetrical Luminaire Types</b>	
Type V, Area Light	B1 U4 G0

\* Backlight, Uplight, Glare

### LIGHT DISTRIBUTION PATTERN

Photometric layouts for general reference only. Squares are 10ft x 10ft. Charts account for 50% light reflectance. Actual light distribution may vary depending on wall material.

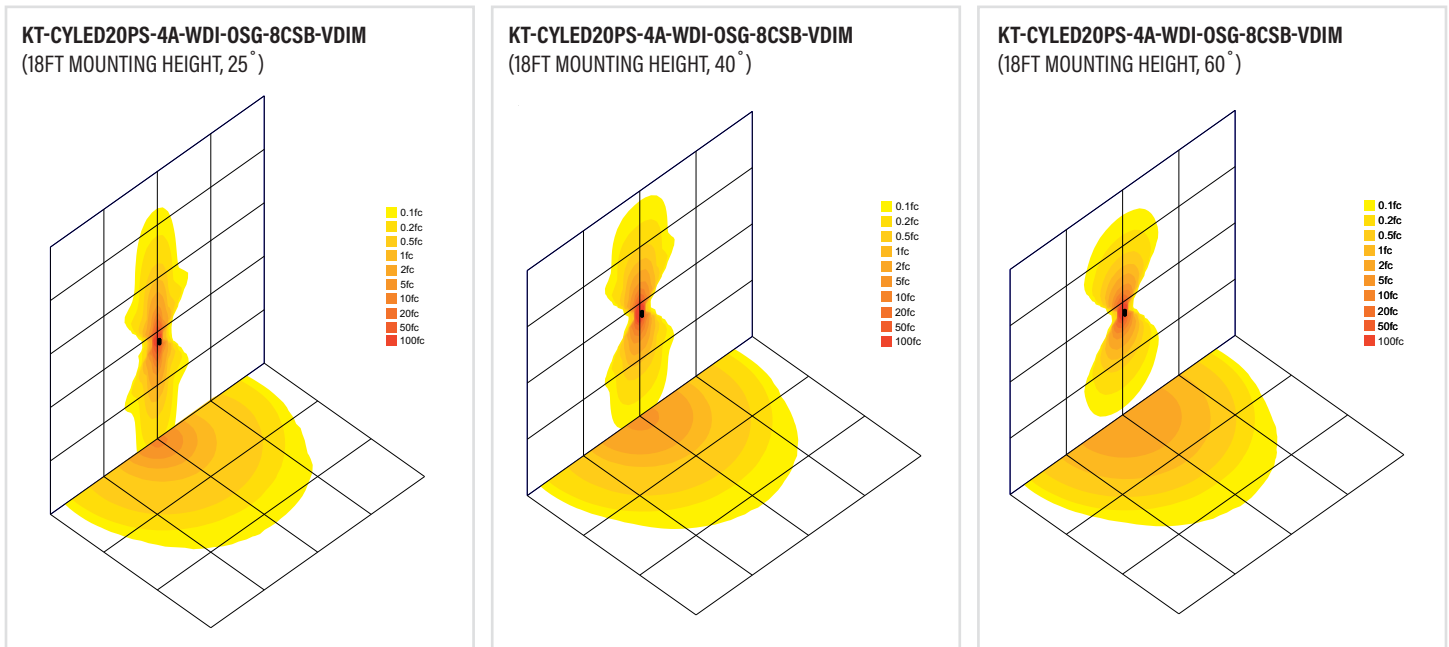

# KT-CYLEDXXPS-XA-WDI-OSG-8CSB-VDIM-X

## DIRECT/INDIRECT WALL MOUNT CYLINDER

### ACCESSORIES

*Note: All shell options are available for 3", 4", and 6" fixture sizes. See last page for ordering details.*

**BRONZE FIXTURE WITH SHELL**



**WHITE FIXTURE WITH SHELL**



**BLACK FIXTURE WITH SHELL**

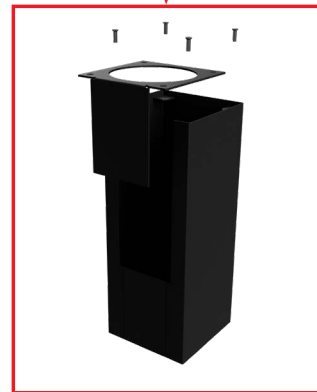
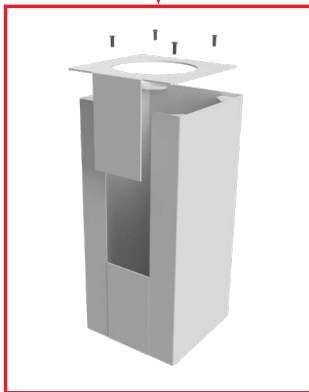



SENTINEL  
WALL MOUNT CYLINDER

Form FIT  
optic swap

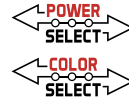

# KT-CYLEDXXPS-XA-WDI-OSG-8CSB-VDIM-X

## DIRECT/INDIRECT WALL MOUNT CYLINDER

### REFLECTOR REPLACEMENT



### WATTAGE, CCT, PHOTOCELL, AND DIRECTION SELECTION

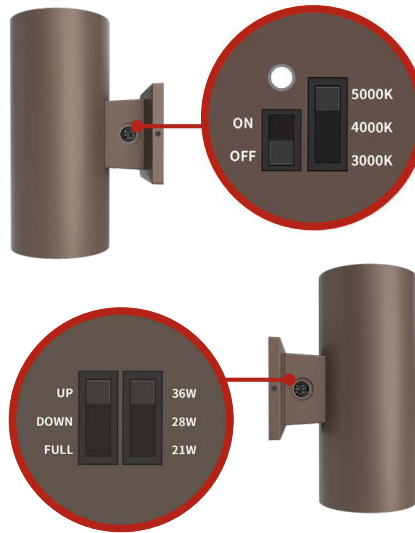

### FORM FIT SHELL ACCESSORY



**Note:** Fixtures are factory preset to their highest wattage and CCT values. Photocell preset to: ON. Direct/Indirect/Full preset to: Full

### PHYSICAL SPECIFICATIONS

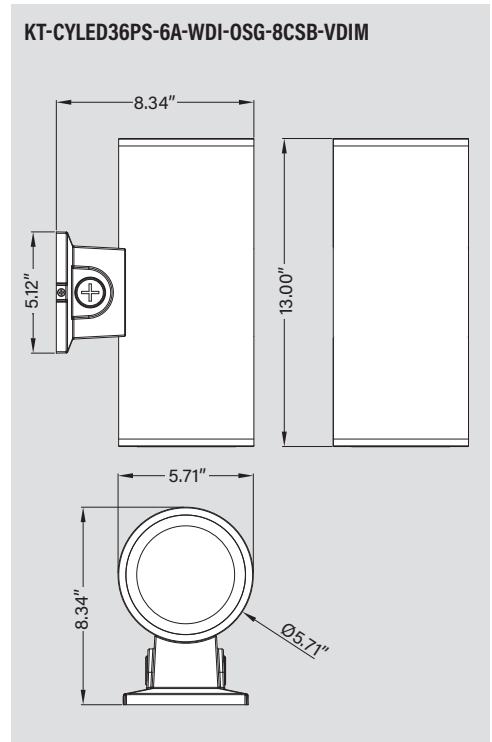
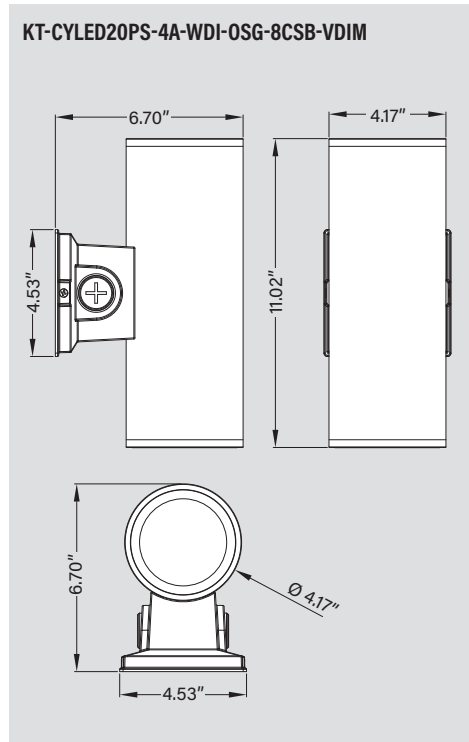
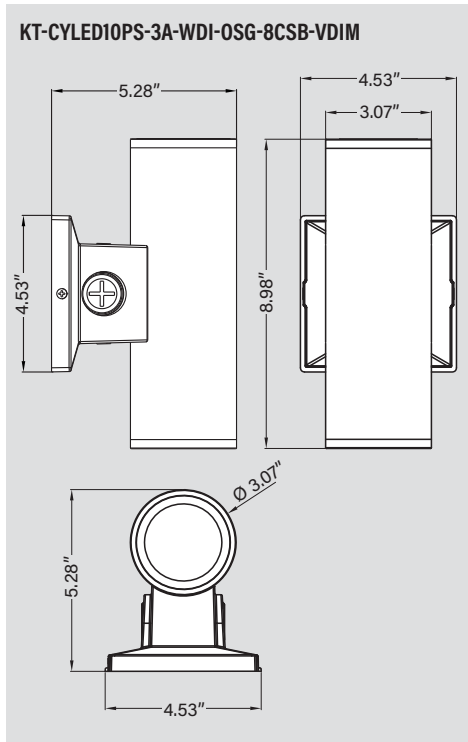

(Physical Specifications continued on next page)

**KT-CYLEDXXPS-XA-WDI-OSG-8CSB-VDIM-X**  
DIRECT/INDIRECT WALL MOUNT CYLINDER

**PHYSICAL SPECIFICATIONS (continued)**

**3" & 4" MOUNTING PLATE**

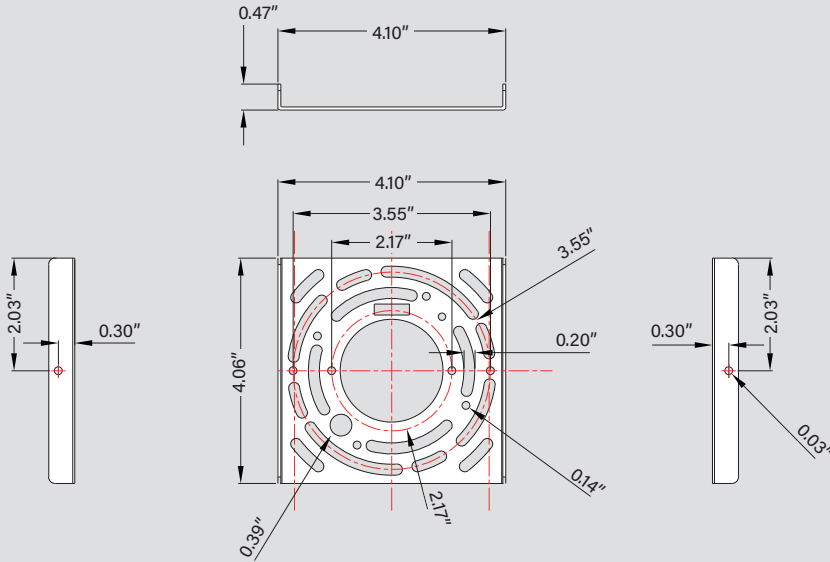

**6" MOUNTING PLATE**

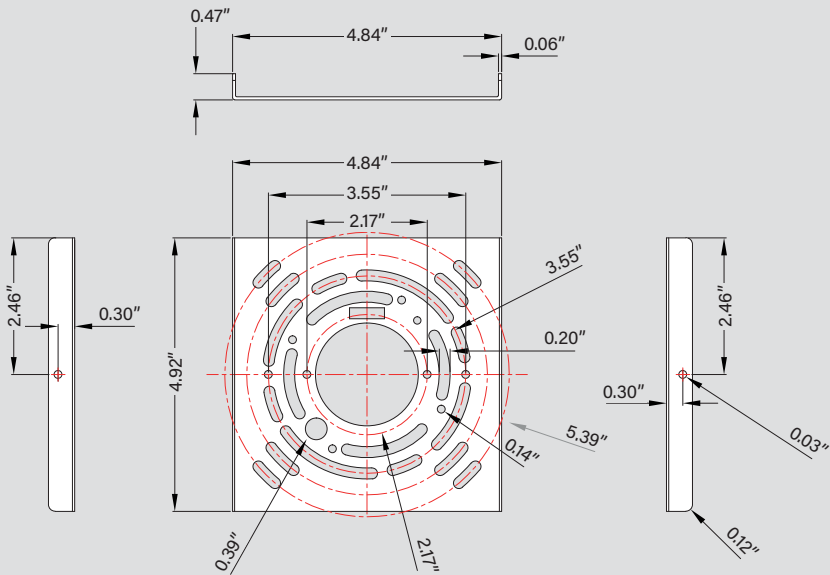



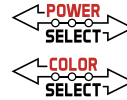

# KT-CYLEDXXPS-XA-WDI-OSG-8CSB-VDIM-X

## DIRECT/INDIRECT WALL MOUNT CYLINDER

**ACCESSORIES**

**SHELLS**

Field-Installable / Field-Use ONLY (purchased separately)

CATALOG NUMBER	DESCRIPTION	HOUSING COLOR	UPC	EASY CODE
KT-CYLED-6A-SQ-1-KIT	Square shell   Used on 6" wall mount cylinders	Bronze	843654162645	UME-71
KT-CYLED-6A-SQ-1-KIT-W	Square shell   Used on 6" wall mount cylinders	White	843654162652	QFQ-38
KT-CYLED-6A-SQ-1-KIT-B	Square shell   Used on 6" wall mount cylinders	Black	843654162669	JHI-09
KT-CYLED-6A-SQ-1-KIT-U*	Square shell   Used on 6" wall mount cylinders	Unpainted	843654162676	LJE-49
KT-CYLED-4A-SQ-1-KIT	Square shell   Used on 4" wall mount cylinders	Bronze	843654162683	DVY-80
KT-CYLED-4A-SQ-1-KIT-W	Square shell   Used on 4" wall mount cylinders	White	843654162690	NGA-14
KT-CYLED-4A-SQ-1-KIT-B	Square shell   Used on 4" wall mount cylinders	Black	843654162706	KBJ-66
KT-CYLED-4A-SQ-1-KIT-U*	Square shell   Used on 4" wall mount cylinders	Unpainted	843654162713	CUL-90
KT-CYLED-3A-SQ-1-KIT	Square shell   Used on 3" wall mount cylinders	Bronze	843654162720	RJL-53
KT-CYLED-3A-SQ-1-KIT-W	Square shell   Used on 3" wall mount cylinders	White	843654162737	OSP-12
KT-CYLED-3A-SQ-1-KIT-B	Square shell   Used on 3" wall mount cylinders	Black	843654162744	ZOK-59
KT-CYLED-3A-SQ-1-KIT-U*	Square shell   Used on 3" wall mount cylinders	Unpainted	843654162751	AOW-72



\*Shell is unpainted. Custom color available. Must provide specific Pantone or RAL number. Lead times apply.

**REFLECTORS**

Field-Installable / Field-Use ONLY (purchased separately)

CATALOG NUMBER	DESCRIPTION	UPC	EASY CODE
KT-CYLED-REFL-6A-15-KIT	15° reflector   Used on 6" wall mount cylinders	843654167282	MHG-76
KT-CYLED-REFL-4A-15-KIT	15° reflector   Used on 4" wall mount cylinders	843654167275	OUY-06
KT-CYLED-REFL-3A-15-KIT	15° reflector   Used on 3" wall mount cylinders	843654167268	ZAP-57
KT-CYLED-REFL-6A-25-KIT	FOR REPLACEMENT PURPOSES ONLY   25° reflector   Used on 6" wall mount cylinders	843654167879	AYP-41
KT-CYLED-REFL-4A-25-KIT	FOR REPLACEMENT PURPOSES ONLY   25° reflector   Used on 4" wall mount cylinders	843654167886	MAW-99
KT-CYLED-REFL-3A-25-KIT	FOR REPLACEMENT PURPOSES ONLY   25° reflector   Used on 3" wall mount cylinders	843654167893	SGD-15
KT-CYLED-REFL-6A-40-KIT	FOR REPLACEMENT PURPOSES ONLY   40° reflector   Used on 6" wall mount cylinders	843654167909	ZUA-50
KT-CYLED-REFL-4A-40-KIT	FOR REPLACEMENT PURPOSES ONLY   40° reflector   Used on 4" wall mount cylinders	843654167916	WMP-02
KT-CYLED-REFL-3A-40-KIT	FOR REPLACEMENT PURPOSES ONLY   40° reflector   Used on 3" wall mount cylinders	843654167923	LJU-89
KT-CYLED-REFL-6A-60-KIT	FOR REPLACEMENT PURPOSES ONLY   60° reflector   Used on 6" wall mount cylinders	843654167930	PFE-95
KT-CYLED-REFL-4A-60-KIT	FOR REPLACEMENT PURPOSES ONLY   60° reflector   Used on 4" wall mount cylinders	843654167947	PJY-93
KT-CYLED-REFL-3A-60-KIT	FOR REPLACEMENT PURPOSES ONLY   60° reflector   Used on 3" wall mount cylinders	843654167954	QYV-77

