

Hourglass Post Top Light



PRODUCT FEATURES:

- ❖ Optical design, greatly improved the light utilization and evenness.
- ❖ High efficiency LED Driver.
- ❖ Cast Aluminum design, better cooling, light quality, LED Tj < 85°C.
- ❖ Excellent efficacy ≥ 140lm/w.

MODEL #	
PROJECT:	
NOTES:	
DATE:	
PREPARED BY:	

Additional Information:

- Power: 60W
- Input: AC 120-277V
- CCT : 4000K/5000K
- Output: 8480 LM
- Light Source: SMD 2835 LEDs
- Driver: WELED POWER



PRODUCT APPLICATIONS:

The Hourglass Post Top Light LED Lighting Series can be widely used for Outdoor (Wet Location) Excellent for Lawns, Courtyards, Roadways and many other applications.

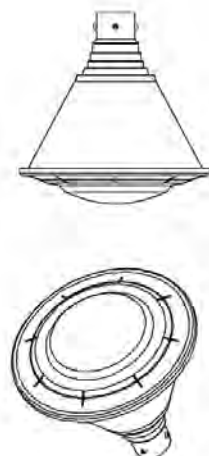
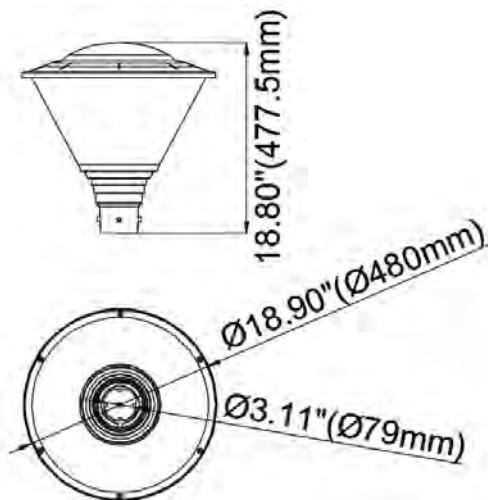

Structure Features:

- Shell Materials: Aluminum & PC
- Finish: Dark Bronze/White/black(Option)
- Net Weight: 5.63KG (12.4LBS)
- **Product Size: 480mm*477.5mm**
- **Carton Size: 505mm*505mm*535mm**

Hourglass Post Top Light

TECHNICAL PARAMETERS:

Type	WSD-HPT06W27-XXK-Z-E		
Power	60W	Lighting Angle	162°
Input Voltage	AC120-277V	LED Brightness Decay	<5%/6000 hrs
PF	≥0.90	Working Life	>75000 hrs
Driver Efficiency	≥87%	Working Temperature	-30 - +45°C
Luminous Flux	8480 Lm	Storage Temperature	-40 - +80°C
Color Temperature	4000K/5000K	Protection Level	Wet Location
CRI	Ra>70	Cable	3core, 18AWG (0.5m)

PHOTOMETRY:

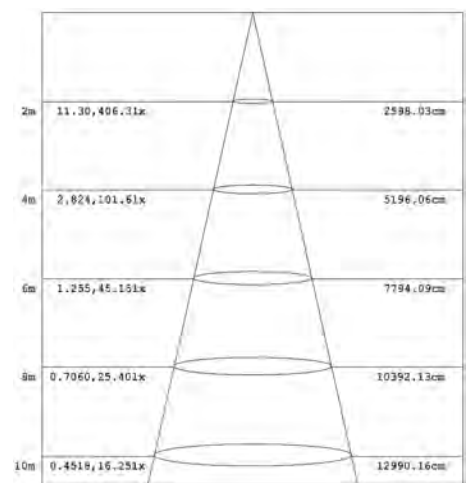
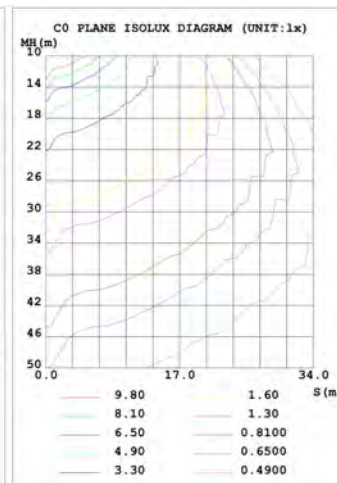
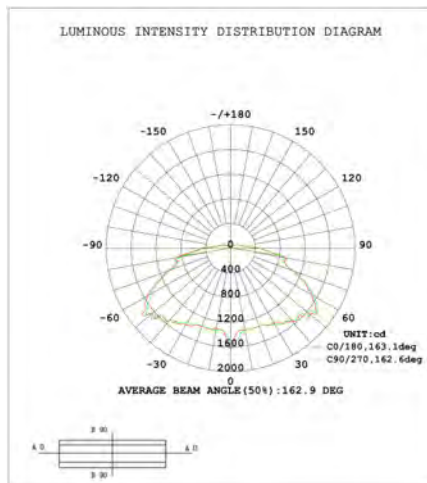

ORDERING EXAMPLE: WSD-HPT06W27-XXK-Z [D, W, B, S] -E [blank,M]

WSD	HPT	06W	27	XXK	Z	E
Company	Product	Power	Voltage	ColorTemp	FINISH	Control
WISDOM	HPT Hourglass Post Top Light	06W (60W)	AC120-277V	40K (4000K) 50K (5000K) ± 500K	D (Dark Bronze) W (White) B (Black) S (Silvery)	M Motion Sensor