

MaxLite® LED ARCHITECTURAL CCT SELECTABLE



General Safety Information

- To reduce the risk of death, personal injury or property damage from fire, electric shock, falling parts, cuts/abrasions, and other hazards read all warnings and instructions included with and on the fixture box and all fixture labels.
- Before installing, servicing, or performing routine maintenance upon this equipment, follow these general precautions.
- Commercial installation, service and maintenance of luminaires should be performed by a qualified licensed electrician.
- For Residential installation: If you are unsure about the installation or maintenance of the luminaires, consult a qualified licensed electrician and check your local electrical code.
- DO NOT INSTALL DAMAGED PRODUCT!
- This fixture is intended to be connected to a properly installed and grounded UL listed junction box.



Picture is for illustration purposes only. Your model may vary.

WARNING:

- Risk of Fire - Supply conductors (power wires) connecting the fixture must be rated minimum 90°C. If uncertain consult an electrician.
- Risk of Fire/Electric Shock - If not qualified, do not attempt installation. Contact a qualified electrician.

CAUTION:

- For your safety read and understand instructions completely before starting installation.
- To prevent wiring damage or abrasion, do not expose wiring to edges of sheet metal or other sharp objects.
- Before attempting installation, check your local electrical code, as it sets the wiring standards for your locality.

NOTES:

- If luminaire (fixture) is to be switched from a wall switch, make sure black power supply wire is connected to the switch. DO NOT connect the white supply wire to the switch.
- Make certain no bare wires are exposed outside the wire nut connectors.
- Do not make or alter any open holes in an enclosure of wiring or electrical components during kit installation.
- Warranty is not applicable to lamps not installed in compliance with:
 - National Electrical Code (NEC)
 - The Standard for Safety of Underwriters Laboratories Inc. (UL)

SERIES: ML2LxA CCT SELECTABLE

Operating Temperature: -20°C to 40°C Damp Location Rated

PRODUCT DIMENSIONS:

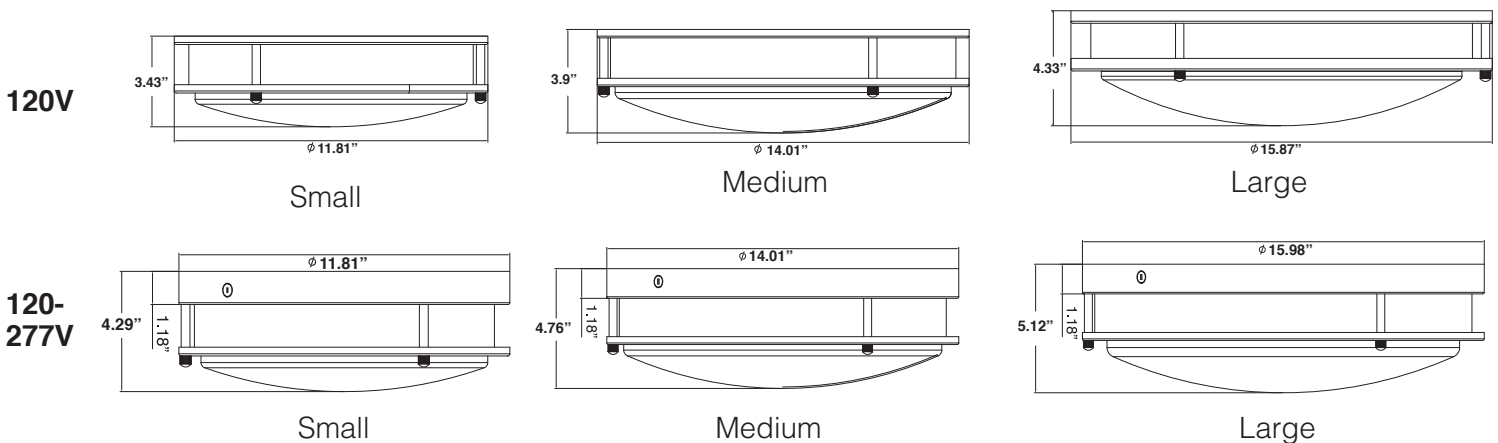

MaxLite® LED ARCHITECTURAL CCT SELECTABLE**Package Contents:**

- | | |
|--|--|
| 1 - Round Flush-mount Housing | 3 - Wirenuts (in parts bag) |
| 1 - Round Flushmount Diffuser (shipped as part of flush mount housing) | 2 - Electrical Box Screws (in parts bag) |
| 1 - Installation Manual | 1 - Mounting Plate (for 16" large only) |

Any Changes expressly or modifications not approved by the party responsible for compliance could void the user's authority to operate the equipment.

This device complies with part 15 of the FCC Rules. Operation is subject to the following two conditions: (1) This device may not cause harmful interference, and (2) this device must accept any interference received, including interference that may cause undesired operation.

Note: This equipment has been tested and found to comply with the limits for a Class B digital device, pursuant to part 15 of the FCC Rules. These limits are designed to provide reasonable protection against harmful interference in a residential installation. This equipment generates, uses and can radiate radio frequency energy and, if not installed and used in accordance with the instructions, may cause harmful interference to radio communications. However, there is no guarantee that interference will not occur in a particular installation. If this equipment does cause harmful interference to radio or television reception, which can be determined by turning the equipment off and on, the user is encouraged to try to correct the interference by one or more of the following measures:

- Reorient or relocate the receiving antenna.
- Increase the separation between the equipment and receiver.
- Connect the equipment into an outlet on a circuit different from that to which the receiver is connected.
- Consult the dealer or an experienced radio/TV technician for help.

FCC Radiation Exposure Statement:

This equipment complies with FCC radiation exposure limits set forth for an uncontrolled environment.

This transmitter must not be co-located or operating in conjunction with any other antenna or transmitter.

This equipment should be installed and operated with minimum distance 20cm between the radiator & you body.

CAN ICES-005(B)/NMB-005(B)

MaxLite® LED ARCHITECTURAL CCT SELECTABLE



General Wiring Diagram

CAUTION: Turn off electrical power at fuse or circuit breaker box before wiring fixture to the power supply.

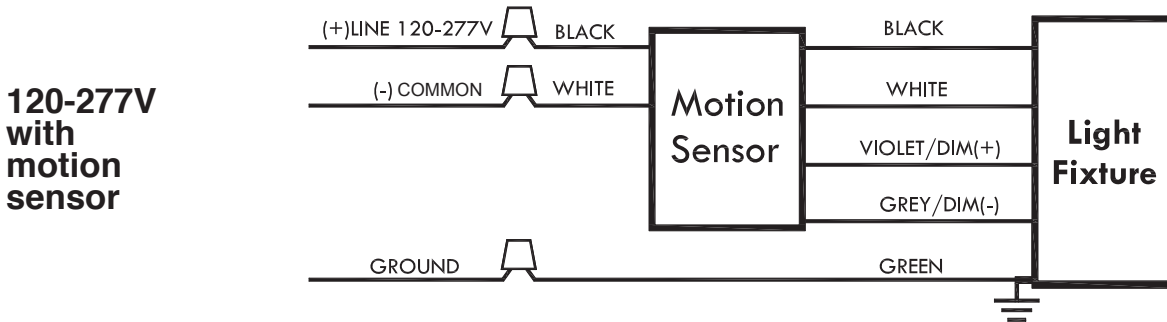
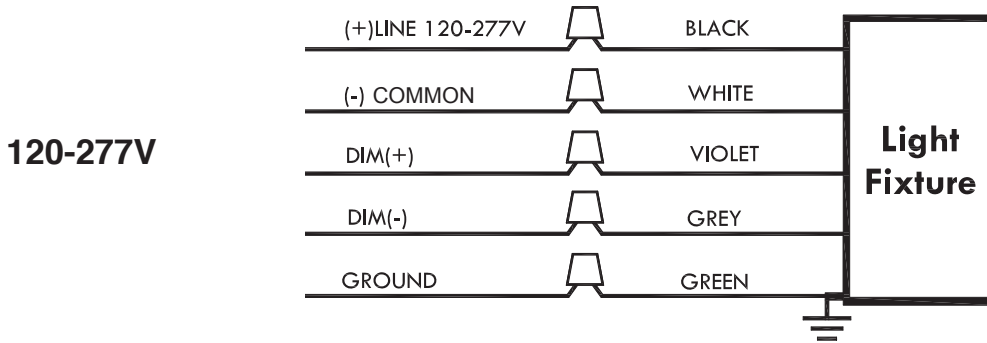
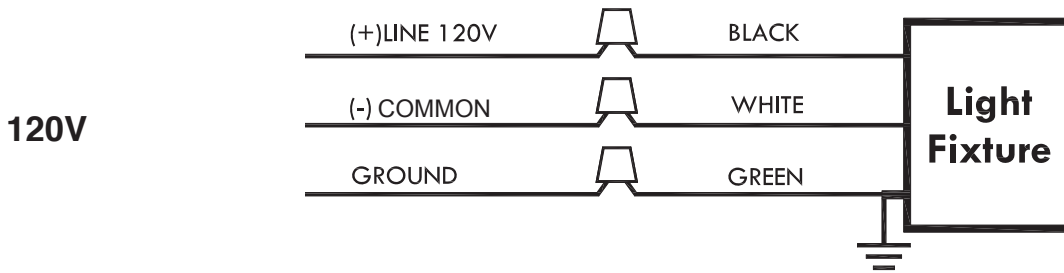



MaxLite® LED ARCHITECTURAL CCT SELECTABLE

Installation & Operation for 12” (small) and 14” (medium)

WARNING:

RISK OF ELECTRICAL SHOCK

- Turn off electrical power at fuse or circuit breaker box before wiring fixture to the power supply.
- Turn off the power when you perform any maintenance.
- Verify that supply voltage is correct by comparing it with the luminaire label information.
- Make all electrical and grounded connections in accordance with the National Electrical Code and any applicable local code requirements.
- All wiring connections should be capped with UL approved wire connectors.

WARNING:

RISK OF INJURY, RISK OF DAMAGE!

- Luminaire may fall if inner bezel is not secured properly to outer bezel. Ensure that the whole loop is positioned and secured under the washer.

- 1.) Before beginning assembly, installation or operation of product, make sure all parts are present. Compare parts with package contents list on previous page. If any part is missing or damaged, do not attempt to assemble, install or operate the product. Contact customer service for replacement parts.
- 2.) Loosen 3 screws counterclockwise and remove lens (Fig. 1).
- 3.) Install the electrical box screws in the junction box (Fig. 2).
- 4.) Follow the correct Wiring diagram to connect wires from luminaires to wires of Junction box.(Fig. 3).
- 5.) Put the fixture plate across the screw of the lock in (Fig. 2), then rotate fixture plate clockwise and lock it tightly with the screw lock (Fig. 4).
- 6.) Select the desired color temperature at the CCT switch (Fig. 5).
- 7.) Securely mount the lens to the fixture housing (Fig. 6).
- 8.) Tighten 3 screw clockwise (Fig. 7).
- 9.) Restore power to the electrical box. Turn the light switch on to activate the fixture.

Fig. 1



Fig. 2



Fig. 3

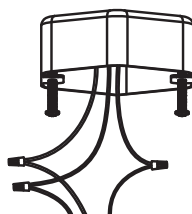

Fig. 4

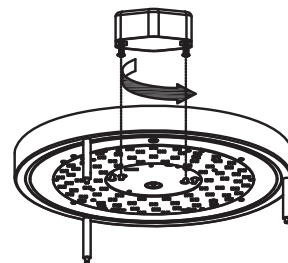

Fig. 5

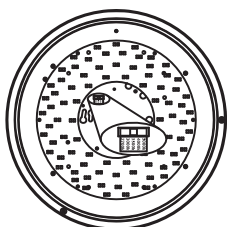

Fig. 6

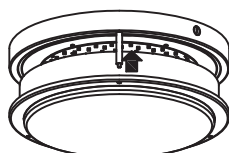
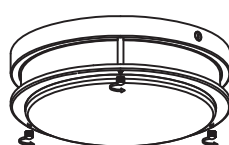

Fig. 7



MaxLite® LED ARCHITECTURAL CCT SELECTABLE



Installation & Operation for 16” (large)

WARNING:

RISK OF ELECTRICAL SHOCK

- Turn off electrical power at fuse or circuit breaker box before wiring fixture to the power supply.
- Turn off the power when you perform any maintenance.
- Verify that supply voltage is correct by comparing it with the luminaire label information.
- Make all electrical and grounded connections in accordance with the National Electrical Code and any applicable local code requirements.
- All wiring connections should be capped with UL approved wire connectors.

WARNING:

RISK OF INJURY, RISK OF DAMAGE!

- Luminaire may fall if inner bezel is not secured properly to outer bezel. Ensure that the whole loop is positioned and secured under the washer.

- 1.) Before beginning assembly, installation or operation of product, make sure all parts are present. Compare parts with package contents list on previous page. If any part is missing or damaged, do not attempt to assemble, install or operate the product. Contact customer service for replacement parts.
- 2.) Loosen 3 screws counterclockwise and remove lens (Fig. 1).
- 3.) Put two shorter mounting screws through Key holes of mounting plate and lock the mounting plate to the junction box, then install the two longer mounting screws to the drilled holes in mounting plate (Fig. 2).
- 4.) Follow the wiring diagram to contact wires from luminaires to wires of Junction box (Fig. 3).
- 5.) Put the fixture plate across the two longer screws of the locked in mounting (Fig. 2), then rotate fixture plate clockwise and lock it tightly with the screw lock (Fig. 4).
- 6.) Select the desired color temperature at the CCT switch (Fig. 5).
- 6.) Securely mount the lens to the fixture housing (Fig. 5).
- 7.) Tighten 3 screw clockwise (Fig. 6).
- 8.) Restore power to the electrical box. Turn the light switch on to activate the fixture.

Fig. 1

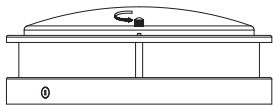

Fig. 2

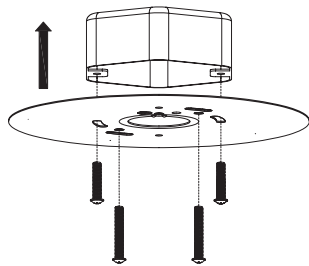

Fig. 3

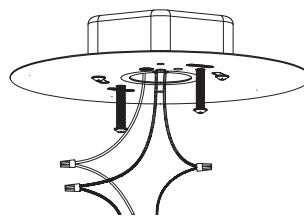

Fig. 4

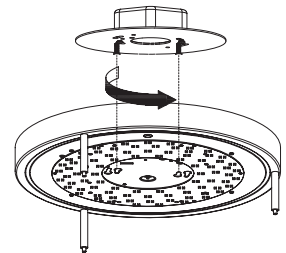

Fig. 5

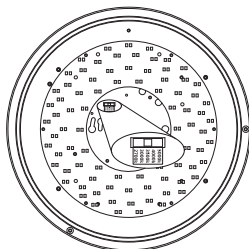

Fig. 6

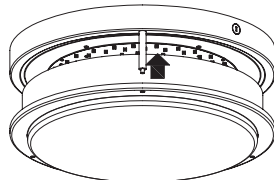
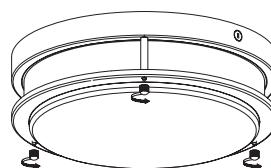

Fig. 7



MaxLite® LED ARCHITECTURAL CCT SELECTABLE



Dip Setting

1) Detection Area

	1	2	
I	ON	ON	100%
II	ON	-	75%
III	-	ON	50%
IV	-	-	10%

2) Hold Time

	3	4	5	
I	ON	ON	ON	5s
II	-	ON	ON	30s
III	ON	-	ON	90s
IV	-	-	ON	3min
V	ON	ON	-	20min
VI	-	-	-	30min

3) Stand-by Period

	6	7	8	
I	ON	ON	ON	0s
II	-	ON	ON	5s
III	ON	-	ON	5min
IV	-	-	ON	10min
V	ON	ON	-	30min
VI	-	ON	-	60min
VII	-	-	-	+ ∞

4) Daylight Sensor

	1	2	3	4	5	6	
I	ON	ON	ON	ON	ON	ON	2lux
II	-	ON	ON	ON	ON	ON	5lux
III	ON	-	ON	ON	ON	ON	15lux
IV	ON	ON	-	ON	ON	ON	25lux
V	ON	ON	ON	-	ON	ON	50lux
VI	ON	ON	ON	ON	-	ON	100lux
VII	ON	ON	ON	ON	ON	-	Disable

5) Stand-by dim Level

	1	2	
I	ON	ON	50%
II	ON	-	35%
III	-	-	25%

MaxLite® LED ARCHITECTURAL CCT SELECTABLE



Radiation Pattern - Ceiling Mounting

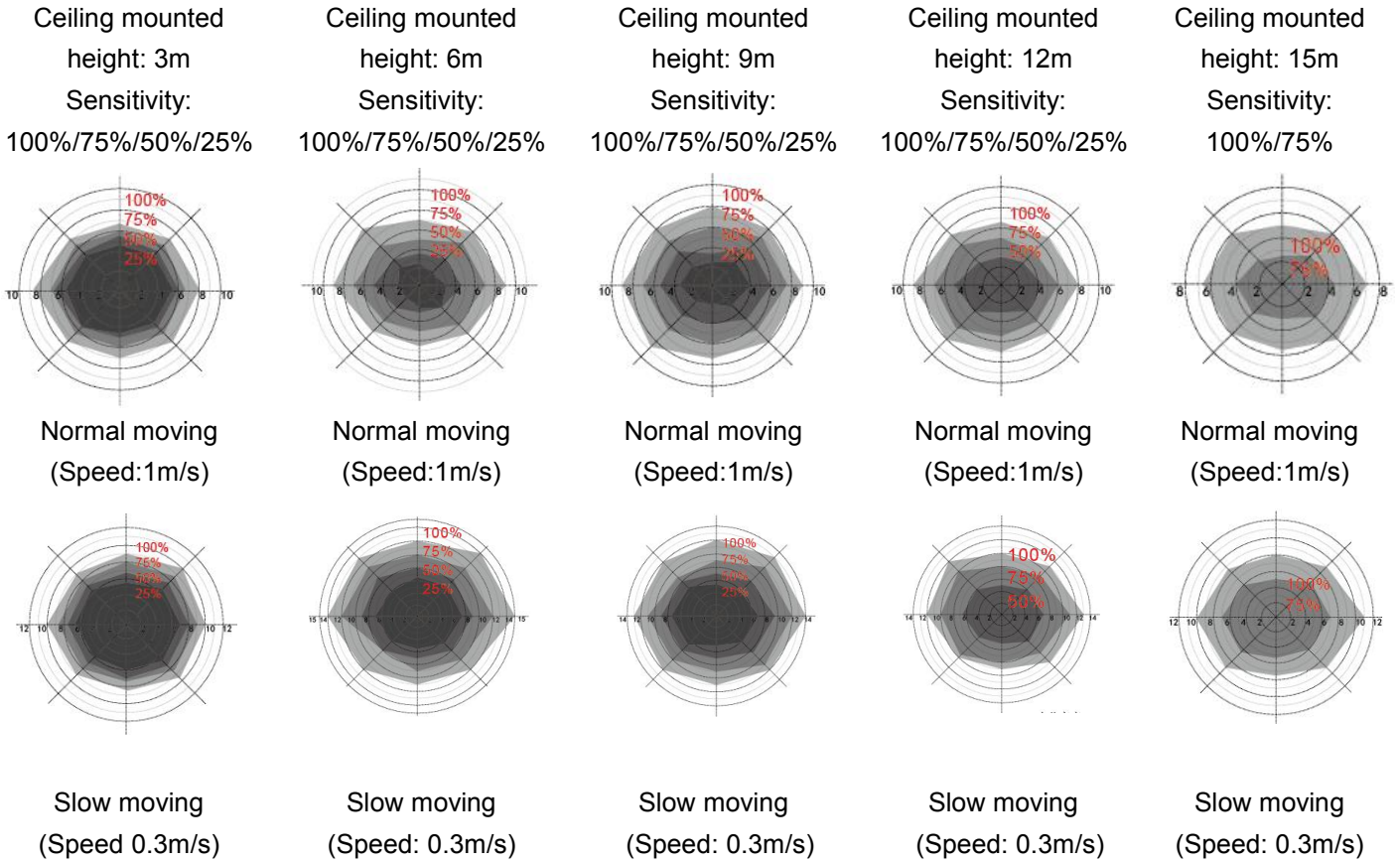

*Only 100%/75%/50% detection sensitivity is workable when installed at 10m & 15m mounting height. 25% sensitivity is not able to detect motion signal.

MaxLite® LED ARCHITECTURAL CCT SELECTABLE



Remote Control

Press the "ON/OFF" button, the light goes to constant on/off mode, sensor is disabled. Press "Reset" "Auto mode" button to quit from this mode and the sensor starts to work.

Press "Reset" button, all parameters are same as setting of DIP switch.

Press "Sensor motion" button, the light quits from the constant on/ off mode, and the sensor starts to work (The latest setting stays in validity)

N/A

N/A

Scene Options	Detection Area	Hold Time	Stand-by period	Daylight Sensor	Induction model
Q1	100%	5min	10min	30Lux	HS
Q2	100%	10min	30min	Disable	HS
Q3	100%	20min	30min	Disable	HS

Note: Detection area / Hold time / Stand-by period / Daylight sensor can be adjusted by pressing the corresponding button. The latest setting will stay valid.

Press the "TEST 2S" button can enter the test mode any time. At the mode, the sensor parameters as below: Detection Area is 100%, Hold Time is 5s, Stand-by Dim Level is 10%, Stand-by Period is 0s, daylight sensor disable. This function only for testing. Quit the mode by pressing "RESET" or any other function buttons.

Press "HS" button to set the detection area to be high sensitive. Press "LS" button to set the detection area to be low sensitive. The adjustment bases on the "Detection Area" parameter you set.

Daylight Sensor
Set up daylight threshold:
5Lux/15Lux/30Lux/50Lux/100Lux/150Lux/ Disable.

Stand-by period
Set up stand-by time: 0S/10S/1 min/3min/5min/10min/30min/+∞

Hold time
Set up hold time: 5S/30S/1min/3min/5min/10min/20min/30min

N/A

Detection Area
Set up detection area: 25%/50%/75%/100%

Remote Distance
Toggle button can set the remote distance of remote control and sensor.

Initialization

1/ On/Off function /3-step dimming function:

After power on, the sensor automatically turns on light at 100% brightness. After 10sec, it turns off the light. During the initialization, the sensor is not able to detect movement.

2/ 2-step dimming function:

After power on, the sensor automatically turns on light at 100% brightness. After 10sec, it dims the light to a low light level (set by stand-by dim level). During the initialization, the sensor is not able to detect movement.

Factory Setting

Detection area: 100%, Hold Time: 5S, Stand-by Period: 0S, Stand-by dim level:10%, Daylight Sensor: Disable

MaxLite® LED ARCHITECTURAL CCT SELECTABLE**Warranty Information**

MaxLite Inc. warrants its products for a minimum period of **FIVE (5)** years from the date of original purchase from MaxLite or its authorized distributor/dealer (the "Warranty Period"), as follows: If a Product fails to operate during the Warranty Period as a result of defects in materials or workmanship, MaxLite will, at its option, repair it, replace it with the same or like Product.

Please refer to Maxlite's website (at <http://www.maxlite.com/resources/warranties>) for the complete terms and conditions of our warranty.

Limitation of Liability

THE FOREGOING WARRANTY IS EXCLUSIVE, AND IS THE SOLE REMEDY FOR ANY AND ALL CLAIMS, WHETHER IN CONTRACT, IN TORT OR OTHERWISE ARISING FROM THE FAILURE OF PRODUCT AND IS IN LIEU OF ALL OTHER WARRANTIES, EXPRESS OR IMPLIED, INCLUDING ALL WARRANTIES OF MERCHANTABILITY OR FITNESS FOR A PARTICULAR PURPOSE, WHICH WARRANTIES ARE HEREBY EXPRESSLY DISCLAIMED TO THE EXTENT PERMITTED BY LAW AND, IN ANY EVENT, SHALL BE LIMITED TO THE WARRANTY PERIOD SPECIFIED ABOVE. THE LIABILITY OF MAXLITE SHALL BE LIMITED TO THE TERMS OF THE EXPRESS WARRANTY SET FORTH HEREIN. IN NO EVENT WILL MAXLITE BE LIABLE FOR ANY SPECIAL, INCIDENTAL OR CONSEQUENTIAL DAMAGES INCLUDING, WITHOUT LIMITATION, DAMAGES RESULTING FROM LOSS OF USE, PROFITS, BUSINESS OR GOODWILL, LABOR COSTS, REMOVAL OR INSTALLATION COSTS, DECREASE IN THE LIGHT OUTPUT OF THE LAMP, AND/OR DETERIORATION IN THE LAMP'S PERFORMANCE, WHETHER OR NOT MAXLITE HAS BEEN ADVISED OF THE POSSIBILITY THEREOF. UNDER NO CIRCUMSTANCES SHALL MAXLITE'S ENTIRE LIABILITY FOR A DEFECTIVE PRODUCT EXCEED THE PURCHASE PRICE OF THAT PRODUCT. WARRANTY SERVICES PROVIDED UNDER THESE TERMS AND CONDITIONS DO NOT ENSURE THE UNINTERRUPTED OPERATION OF PRODUCTS; MAXLITE SHALL NOT BE LIABLE FOR DAMAGES CAUSED BY ANY DELAYS INVOLVING WARRANTY SERVICE.

This Limited Warranty gives you specific legal rights and you may also have other rights that may vary from state to state. Because some states or jurisdictions do not allow the exclusion or limitation of liability for consequential or incidental damages, this limitation may not apply to you.