



PARKING LOT FIXTURES



SPECIFICATION FEATURE:

- DESIGNED FOR INSTALLING NEW CONSTRUCTION OR RETROFITTING EXISTING COMMERCIAL BUILDINGS
- 10V SURGE PROTECTION FROM LIGHTENING STRIKE
- OVER 133 LPW TO BRING BETTER LIGHT QUALITY FOR TARGETED AREA
- FOUR BRACKETS DESIGNED TO EASY-INSTALL
- TYPE III, IV OR V LIGHTING DISTRIBUTION TYPE



ACCESSORIES OPTIONS:



PHOTOCELL



MOTION SENSOR

LARGE 250 - 300 W

MEDIUM 150 W

COMPACT 70 - 105 W

INPUT VOLTAGE	110 - 277 VAC / 480 VAC
CRI	>70
LUMEN PER WATT	130 LM/W
AVAILABLE CCT	4000K,5000K
LIFE SPAN	50,000 HOURS
OPERATION TEMPERATURE	-40°F - 113°F
BEAM ANGLE	DUE TO OPTICAL TYPE
MOUNTING OPTIONS	DIRECT ARM MOUNT, SLIP FITTER, TRUNNION MOUNT, WALL MOUNT

INPUT VOLTAGE	110 - 277 VAC / 480 VAC
CRI	>70
LUMEN PER WATT	130 LM/W
AVAILABLE CCT	4000K,5000K
LIFE SPAN	50,000 HOURS
OPERATION TEMPERATURE	-40°F - 113°F
BEAM ANGLE	DUE TO OPTICAL TYPE
MOUNTING OPTIONS	DIRECT ARM MOUNT, SLIP FITTER, TRUNNION MOUNT, WALL MOUNT

INPUT VOLTAGE	110 - 277 VAC / 480 VAC
CRI	>70
LUMEN PER WATT	130 LM/W
AVAILABLE CCT	4000K,5000K
LIFE SPAN	50,000 HOURS
OPERATION TEMPERATURE	-40°F - 113°F
BEAM ANGLE	DUE TO OPTICAL TYPE
MOUNTING OPTIONS	DIRECT ARM MOUNT, SLIP FITTER, TRUNNION MOUNT, WALL MOUNT

ORDERING OPTIONS

EXAMPLE: LED4PK 250W 50K 3

LARGE 250 - 300W

LED4PK	250W	50K	[BLANK]	3	[BLANK]	[BLANK]
SERIES LED4PK	RATED WATTAGE 250W 250 WATT 300W 300 WATT	COLOR TEMP 40K 4000 KELVIN 50K 5000 KELVIN	INPUT VOLTAGE BLANK 110 - 277 VAC HV 480 VAC	DISTRIBUTION TYPE 3 TYPE III 4 TYPE IV 5 TYPE V	FINISHING BLANK DARK BRONZE BK BLACK WH WHITE SG SILVER GRAY	OPTIONS -PC TWIST LOCK PHOTOCELL -MS MOTION SENSOR

EXAMPLE: LED4PK 150W 50K 3

MEDIUM 150W

LED4PK	150W	50K	[BLANK]	3	[BLANK]	[BLANK]
SERIES LED4PK	RATED WATTAGE 150W 150 WATT	COLOR TEMP 40K 4000 KELVIN 50K 5000 KELVIN	INPUT VOLTAGE BLANK 110 - 277 VAC HV 480 VAC	DISTRIBUTION TYPE 3 TYPE III 4 TYPE IV 5 TYPE V	FINISHING BLANK DARK BRONZE BK BLACK WH WHITE SG SILVER GRAY	OPTIONS -PC TWIST LOCK PHOTOCELL -MS MOTION SENSOR

EXAMPLE: LED4PK 70W 50K 3

COMPACT 70 - 105W

LED4PK	70W	50K	[BLANK]	3	[BLANK]	[BLANK]
SERIES LED4PK	RATED WATTAGE 70W 70 WATT 105W 105 WATT	COLOR TEMP 40K 4000 KELVIN 50K 5000 KELVIN	INPUT VOLTAGE BLANK 110 - 277 VAC HV 480 VAC	DISTRIBUTION TYPE 3 TYPE III 4 TYPE IV 5 TYPE V	FINISHING BLANK DARK BRONZE BK BLACK WH WHITE SG SILVER GRAY	OPTIONS -PC TWIST LOCK PHOTOCELL -MS MOTION SENSOR



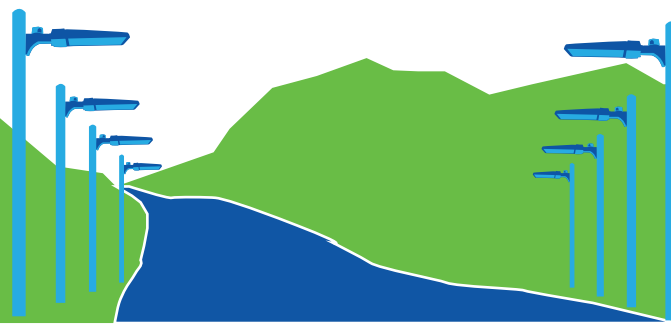

PARKING LOT FIXTURES

DIMENSIONS

LARGE 250 - 300W

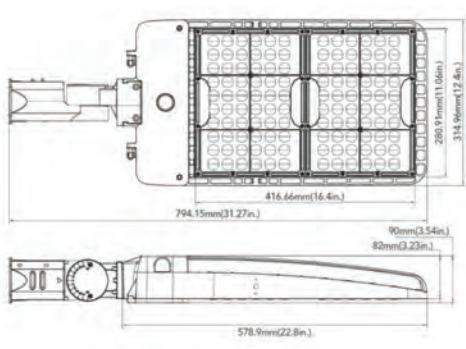

MEDIUM 150W

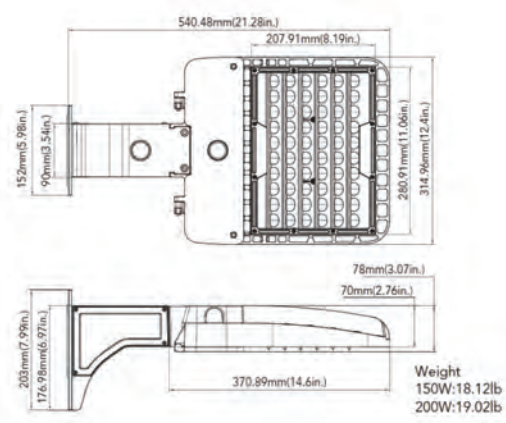

COMPACT 70W - 105W

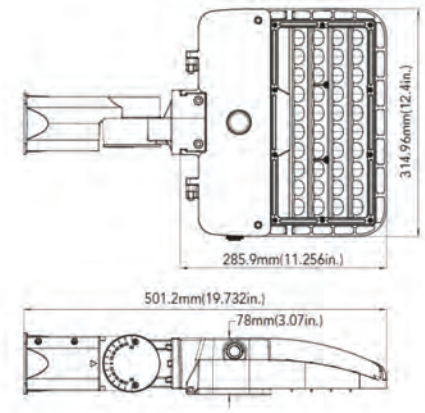

LIGHT DISTRIBUTION TYPE

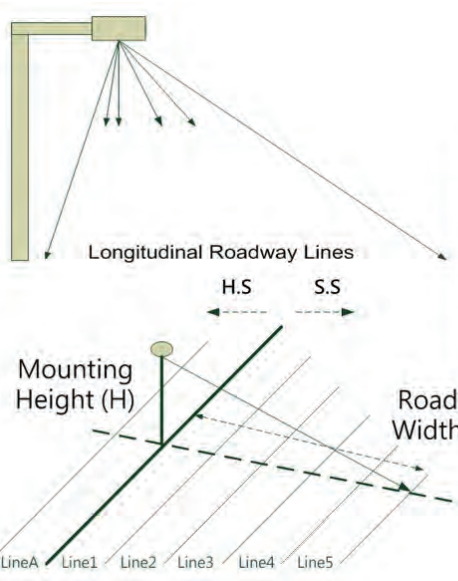

WH ratio = W / H

	W/H
Type I	-1 ~ +1
Type II	1 ~ 1.75
Type III	1.75 ~ 2.75
Type IV	> 2.75

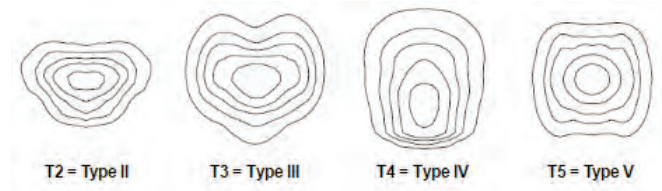

EXAMPLE

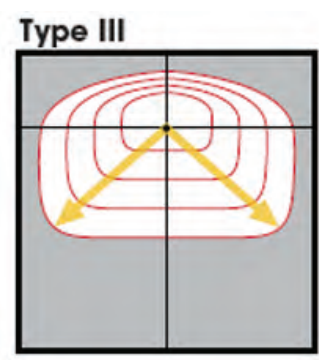

OPTIONAL ACCESSORIES

TWIST LOCK PHOTOCELL

Optional photocontrol allows for further energy saving.



PIR BI-LEVEL MOTION SENSOR

Optional PIR sensor allows for security and energy saving.

MOUNTING OPTIONS



SLIPFITTER MOUNT (-SP)



ARM MOUNT (-AM)



TRUNNION MOUNT (-TM)



WALL MOUNT (-WM)



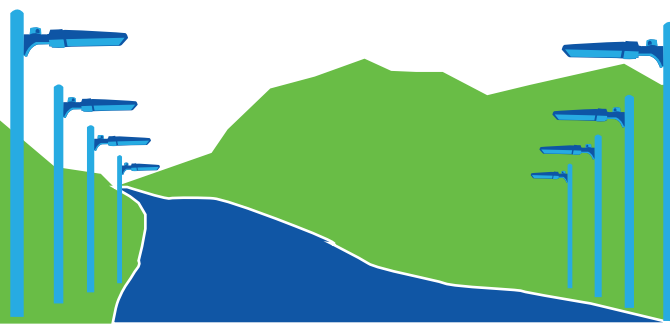

TENON & MOUNTING CONFIGURATIONS



Double 90 degree

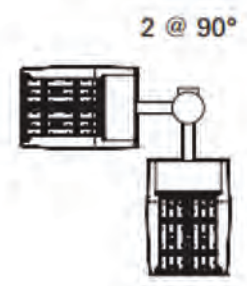
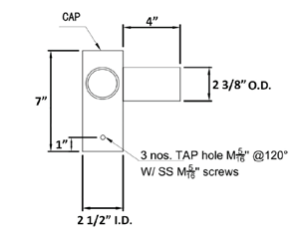

Double 180 degree

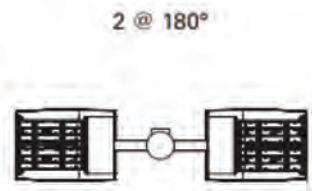
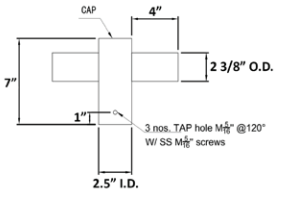

Triple 90 degree

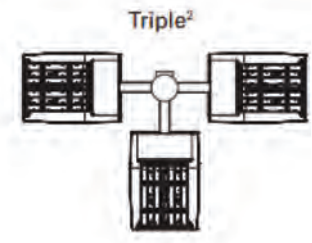
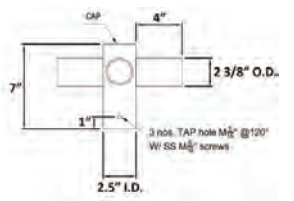

Triple 120 degree

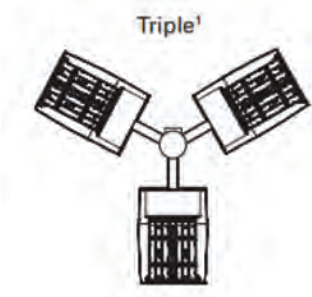
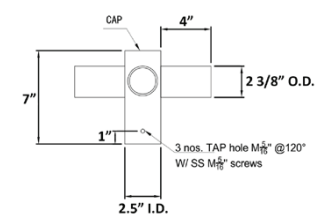

Quad 90 degree

