



KT-LED45HID-H-EX39-850-D

HID REPLACEMENT LED LAMP

DESCRIPTION

45W HID Replacement LED Lamp | 5000K | 85 CRI | IP64 Rated



LAMP TYPE: HID Replacement LED
BASE TYPE: EX39 (Mogul) Rotatable
WATTAGE: 45W
COLOR TEMPERATURE: 5000K
METAL HALIDE EQUIVALENT: 175W
COLOR RENDERING INDEX (CRI): 85
WARRANTY: 5 Years



PRODUCT FEATURES

- Replacement for conventional metal halide lamp
- Ideal for wallpack retrofit applications
- Optimized for horizontal applications with directional light output from opening LED assembly construction
- Non-dimmable; Do not dim
- 50,000+ hour lifetime
- Environmentally friendly: No mercury used
- Instant startup
- DLC Listed
- UL Listed
- Operating temperature: -40°C/-40°F to 45°C/113°F in enclosed fixture
- Integral driver, eliminates the need for external driver or ballast; Includes 4kV surge protection
- IP64 Rated; integrated heat sink quickly dissipates heat and guides water intrusion out of the lamp
- Horizontal orientation
- Suitable for use in fully enclosed fixture

OPERATING SPECIFICATIONS

ELECTRICAL CHARACTERISTICS

Input Voltage	Power Consumption	Power Factor	Input Current
120-277Vac	45W	>0.9	0.38A @ 120V 0.16A @ 277V

RATED LIFE

L70 (Hours)	50,000
-------------	--------

PHOTOMETRIC CHARACTERISTICS

Color Temperature (CCT)	5000K
Luminous Flux	6,400 lm
Color Rendering Index (CRI)	85
Efficacy	142 lm/W
Beam Angle	180°

SPECTRAL DISTRIBUTION

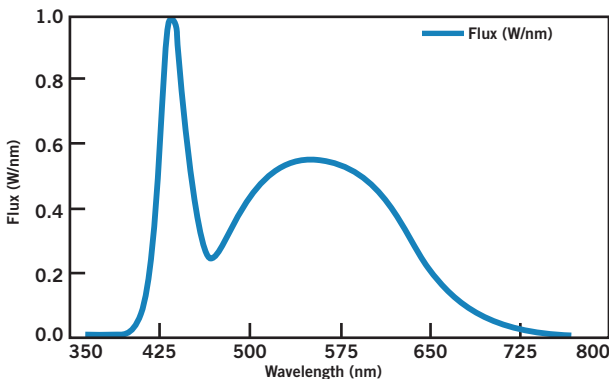

LUX DISTANCE CURVE

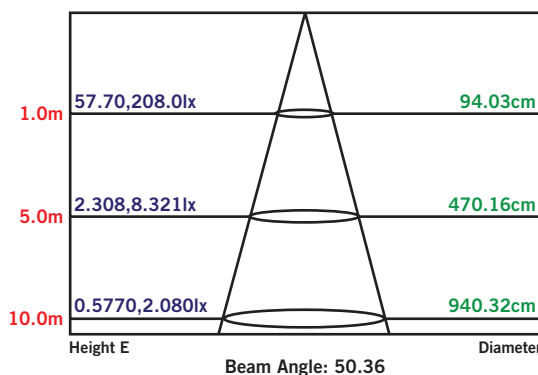



KT-LED45HID-H-EX39-850-D

HID REPLACEMENT LED LAMP

WIRING DIAGRAM

STEP 1

Disconnect power. Disconnect and remove existing ballast, capacitor, and/or ignitor (where applicable) from fixture.

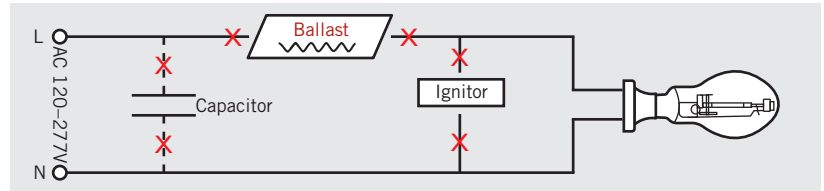

STEP 2

Rewire for line voltage to the lamp socket.

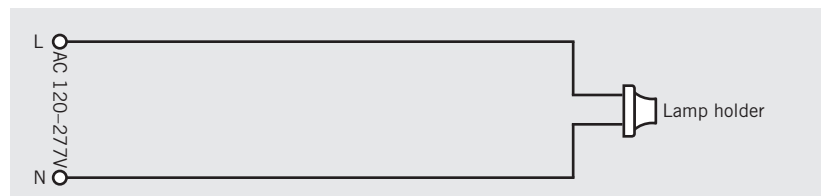

STEP 3

Install new LED replacement lamp. Ensure lamp is operating properly when power is turned on.

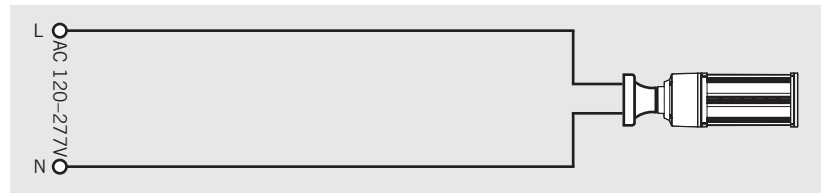
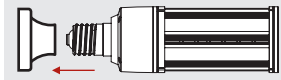

STEP 4

Rotate lamp base and open wings accordingly toward direction of desired lumination.

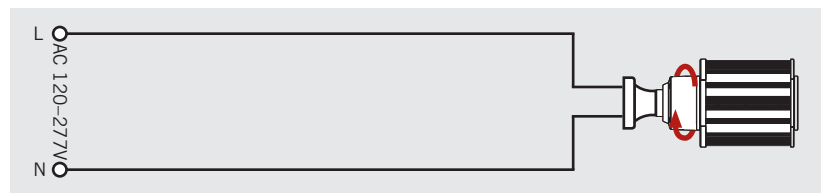

PHYSICAL CHARACTERISTICS

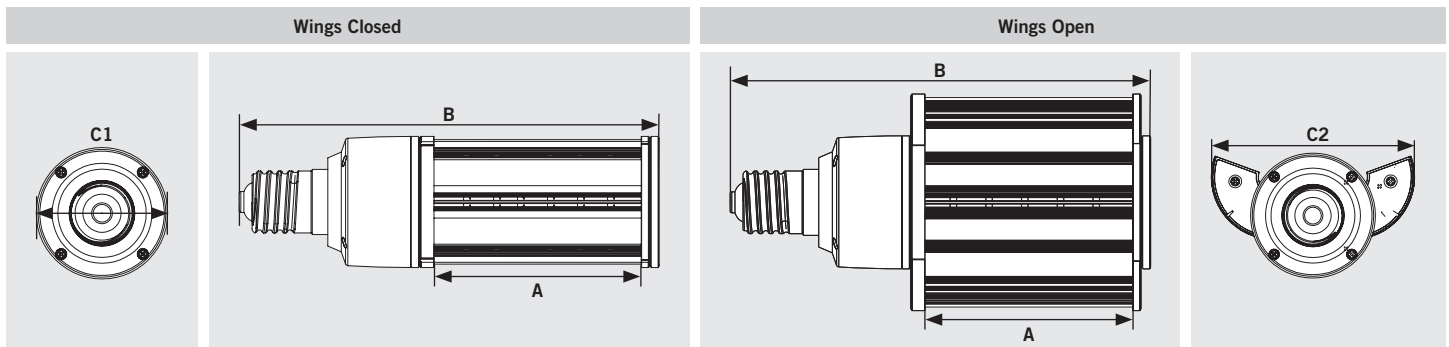

LAMP DIMENSIONS

A (Illuminated Length)	5.83"	C (Diameter)	3.23"
B (Body Length)	9.76"	C2 (Width, Wings Open)	5.26"

BASE TYPE: EX39 (Mogul) Rotatable



KT-LED45HID-H-EX39-850-D

HID REPLACEMENT LED LAMP

ORDERING INFORMATION

Order Code	Packaging Style	Pack Quantity	Item Status
KT-LED45HID-H-EX39-850-D-DP	Distributor Pack (Individual Cartons)	16	Quick Ship

CATALOG NUMBER BREAKDOWN

KT-LED45HID-H-EX39-850-D-DP

- 1 Keystone Technologies
- 2 LED Lamp
- 3 Wattage
- 4 Lamp Type
- 5 Horizontal Orientation
- 6 Base Type
- 7 800 Series
- 8 Color Temperature
- 9 DirectDrive Series
- 10 Packaging Style