

KT-ALED100-S1-X-NM-8XX-VDIM

LED AREA LIGHT FIXTURES

DESCRIPTION

Compact 100W High-Performance LED Area Light |
 120–277V Input | Bronze Housing |
 Multiple Mounting, Optics, and Control options

APPLICATION

Pole-mount or structure-mount outdoor illumination needs (including parking lots, auto dealerships, pathways, roadways, recreational venues, and other general area lighting requirements)



PRODUCT FEATURES

- Compact, low-profile design delivers high-performance illumination and improves application site aesthetics
- Heavy-duty, die-cast aluminum housing with ample heat sinking for enhanced thermal performance
- True U0 design for Dark Sky compliant performance eliminates undesirable sky glow
- Integrated NEMA/ANSI C136.10 3-pin twist-lock receptacle with shorting cap, standard on all fixtures, simplifies ordering requirements for photo control needs
- Precision-crafted optics, available with type II, III, IV, and V patterns, to meet diverse requirements from general purpose to specification-grade applications
- Integral latch design for hassle-free, hinged access to driver compartment
- Four contractor-friendly mounting options available (sold separately): slip fitter mount, adjustable pole mount for square and round poles, fixed pole mount for square and round poles, and trunnion mount
- Bi-level occupancy sensors and twist-lock photocell accessories available
- Reversible glare shield available, suitable for backside (house-side) or frontside (street-side) shielding
- Powered by Keystone 0–10V dimming LED driver featuring 12V AUX power tap, 6kV surge protection
- Ambient operating temperature: –40°C/–40°F to 50°C/122°F
- UL Certified for wet locations, IP65
- 0–10V dimming, 10% min
- Power factor: >0.95
- THD: <20%
- LED chip lifetime: L70 >100,000 hrs @ 25°C/77°F ambient fixture temp
- Meets FCC Part 15, Part B, Class A standards for conducted and radiated emissions

ELECTRICAL SPECIFICATIONS

Catalog Number	Wattage	Lumens	Efficacy	Dimming	Color Temp	CRI	Dist Type*	Input Voltage	Rated Life	Legacy Equivalent	Housing Color**	Additional Feature
KT-ALED100-S1-3-NM-840-VDIM	100W	13,700 lm	137 lm/W	0–10V	4000K	>80	III	120–277V	50,000 hrs	250–320W	Bronze	10kV external surge protection included
KT-ALED100-S1-3-NM-850-VDIM		13,900 lm	139 lm/W		5000K		III					
KT-ALED100-S1-5-NM-840-VDIM		13,800 lm	138 lm/W		4000K		V					
KT-ALED100-S1-5-NM-850-VDIM		14,000 lm	137 lm/W		5000K		V					

* Fixtures with Type 2 (II) and Type 4 (IV) optics are available and assembled to order. Lead times may apply. Please see catalog number breakdown for full ordering code details.

** Fixtures (and mounts) with alternate housing colors are available and made to order. Extended lead times apply. Please see catalog number breakdown for full ordering code details.

KT-ALED100-S1-X-NM-8XX-VDIM
LED AREA LIGHT FIXTURES

MOUNTING BRACKET OPTIONS (SOLD SEPARATELY)

SLIP FITTER MOUNT

Fits 2 3/8" tenon; Bronze

Catalog Number	UPC	Easy Code
KT-ALED-SF-1-KIT	843654131641	JRH-74

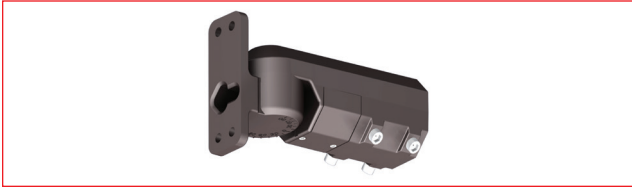

ADJUSTABLE POLE MOUNT

For round or square pole; Bronze

Catalog Number	UPC	Easy Code
KT-ALED-PMA-1-KIT	843654131634	DAQ-87

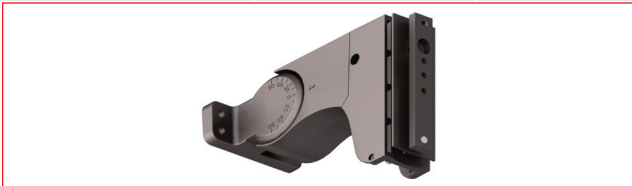

FIXED POLE MOUNT

For round or square pole; Bronze

Catalog Number	UPC	Easy Code
KT-ALED-PM-1-KIT	843654131627	QVG-29



TRUNNION MOUNT

Bronze

Catalog Number	UPC	Easy Code
KT-ALED-TM-1-KIT	843654131658	GTH-37

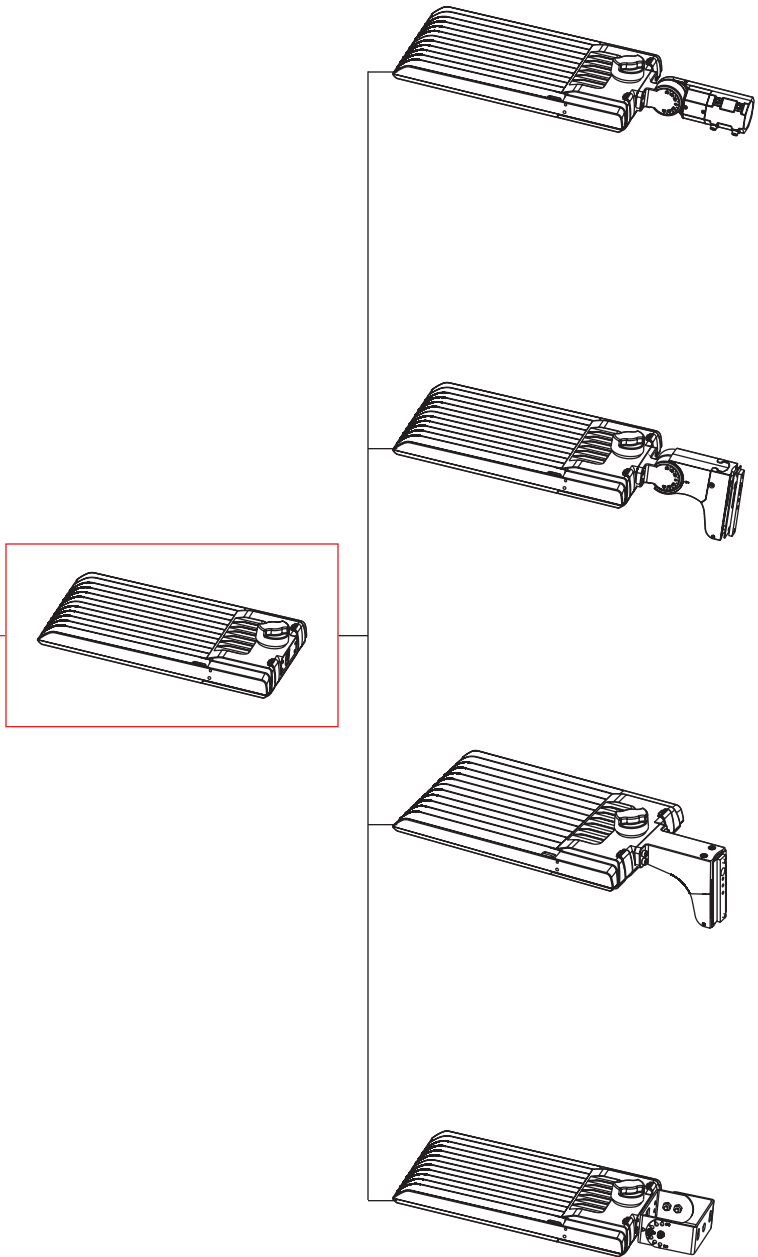
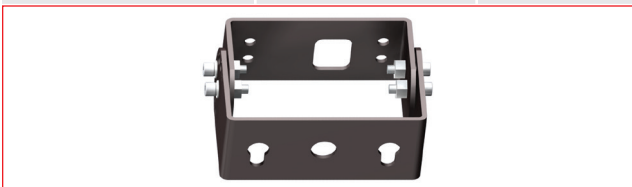



KT-ALED100-S1-X-NM-8XX-VDIM

LED AREA LIGHT FIXTURES

PHYSICAL SPECIFICATIONS

LED AREA LIGHT FIXTURE

PACKAGING

Carton Quantity	1 piece
Carton Dimensions	6.1\"H x 11.22\"W x 22.63\"L
Carton Weight	7.72 lbs

POLE MOUNT (ADJUSTABLE OR FIXED) DRILLING HOLES

KT-ALED100-S1-X-NM-8XX-VDIM
LED AREA LIGHT FIXTURES

WIRING DIAGRAM

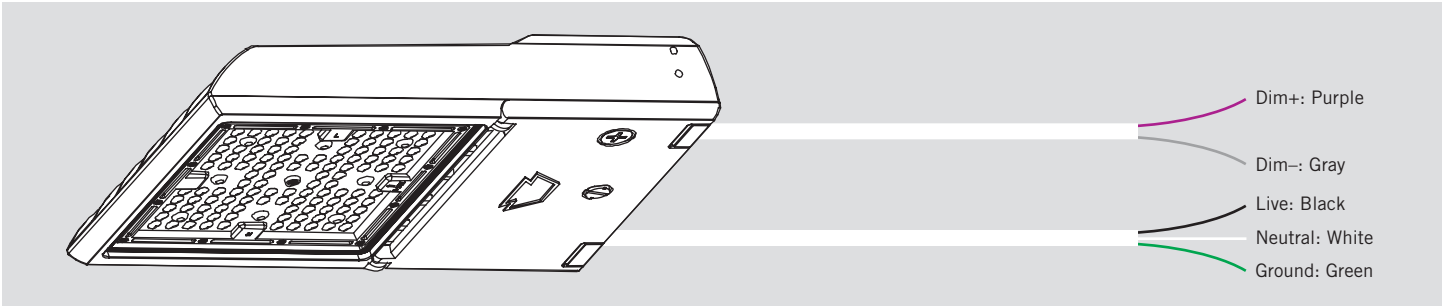

LIGHT DISTRIBUTION PATTERN

TYPE 3 (III)

Pole-mount view from above; Area light mounted at 25'

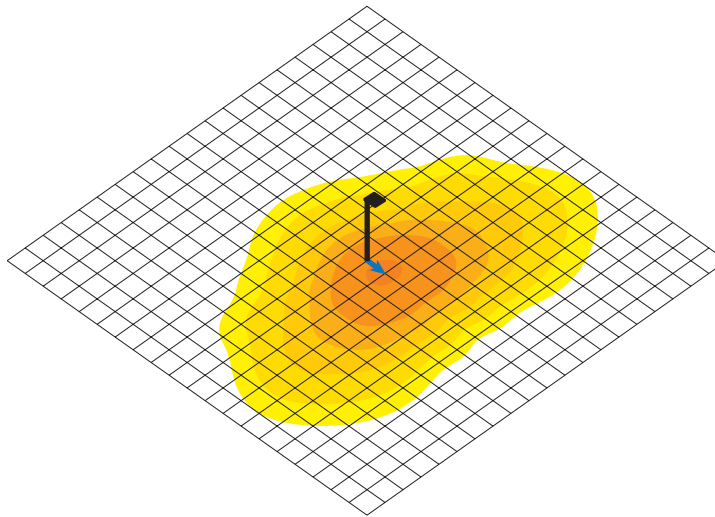

TYPE 5 (V)

Pole-mount view from above; Area light mounted at 25'

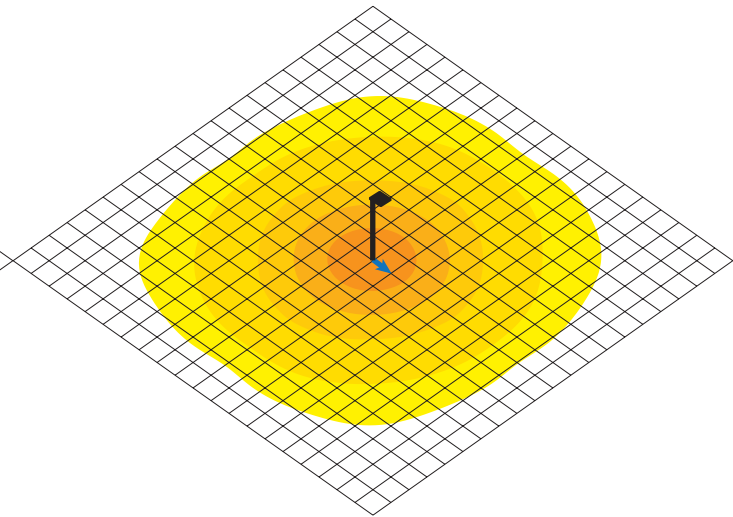

- Photometric layout for general reference only
- Grid dimension: 10 x 10 sq ft

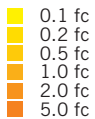

- Photometric layout for general reference only
- Grid dimension: 10 x 10 sq ft

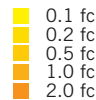

KT-ALED100-S1-X-NM-8XX-VDIM
LED AREA LIGHT FIXTURES

PHOTOMETRIC SPECIFICATIONS (TYPE 3 [III])

ISOCANDELA PLOT

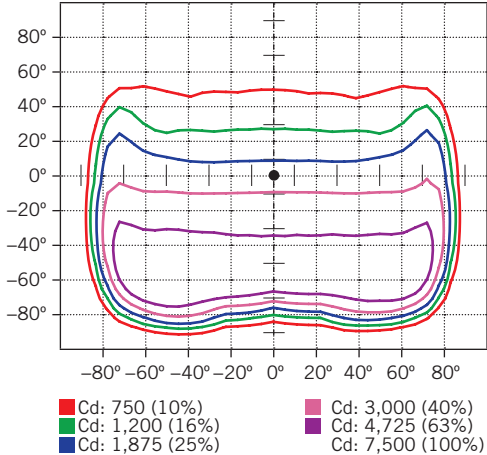

LUMINOUS INTENSITY DISTRIBUTION

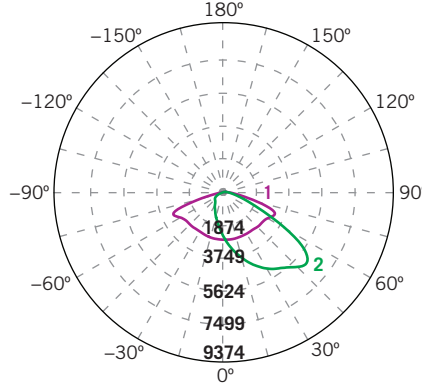

Average diffuse angle (50%): **106.9°**
1 Violet C0-C180
2 Green C90-C270
 Unit: cd

FLUX DISTRIBUTION

Zone	Lumens	% Luminaire
Forward Light	10,907 lm	78.7%
0°-30°	1,524 lm	11.0%
30°-60°	5,782 lm	41.7%
60°-80°	3,475 lm	25.1%
80°-90°	126 lm	0.9%
Back Light	2,949 lm	21.3%
0°-30°	781 lm	5.6%
30°-60°	1,385 lm	10.0%
60°-80°	733 lm	5.3%
80°-90°	49 lm	0.4%
Up Light	0 lm	0.0%
90°-100°	0 lm	0.0%
100°-180°	0 lm	0.0%

BUG* Rating	
Asymmetrical Luminaire Types	
Type I, II, III, IV	B2 U0 G2
Quadrilateral Symmetrical Luminaire Types	
Type V, Area Light	B2 U0 G2

* Backlight, Uplight, Glare

PHOTOMETRIC SPECIFICATIONS (TYPE 5 [V])

ISOCANDELA PLOT

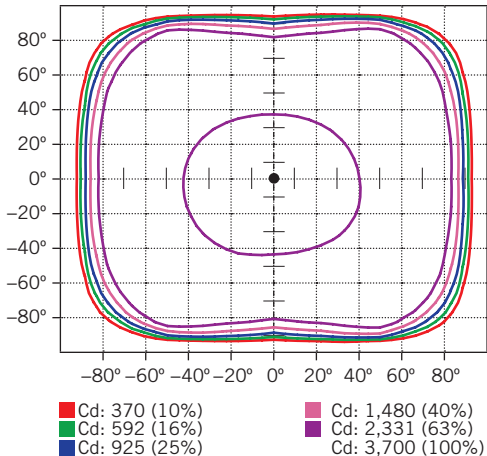

LUMINOUS INTENSITY DISTRIBUTION

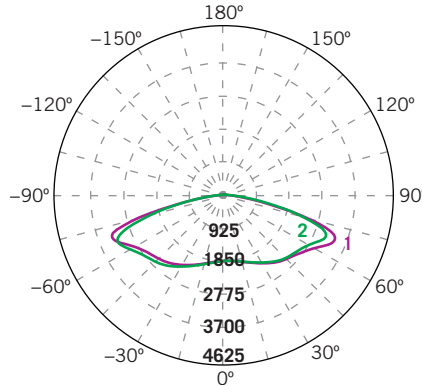

Average diffuse angle (50%): **154.2°**
1 Violet C0-C180
2 Green C90-C270
 Unit: cd

FLUX DISTRIBUTION

Zone	Lumens	% Luminaire
Forward Light	6,820 lm	49.2%
0°-30°	832 lm	6.0%
30°-60°	2,782 lm	20.1%
60°-80°	2,874 lm	20.7%
80°-90°	332 lm	2.4%
Back Light	7,043 lm	50.8%
0°-30°	856 lm	6.2%
30°-60°	2,925 lm	21.1%
60°-80°	2,962 lm	21.4%
80°-90°	299 lm	2.2%
Up Light	0 lm	0.0%
90°-100°	0 lm	0.0%
100°-180°	0 lm	0.0%

BUG* Rating	
Asymmetrical Luminaire Types	
Type I, II, III, IV	B4 U0 G4
Quadrilateral Symmetrical Luminaire Types	
Type V, Area Light	B4 U0 G3

* Backlight, Uplight, Glare

KT-ALED100-S1-X-NM-8XX-VDIM
LED AREA LIGHT FIXTURES

PHOTOMETRIC SPECIFICATIONS (TYPE 4 [IV])

ISOCANDELA PLOT

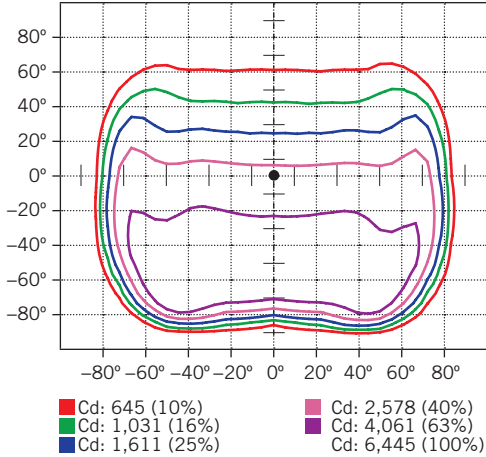

LUMINOUS INTENSITY DISTRIBUTION

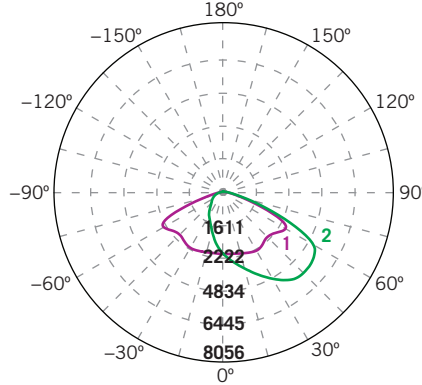

Average diffuse angle (50%): **105.3°**
1 Violet C0-C180
2 Green C90-C270
 Unit: cd

FLUX DISTRIBUTION

Zone	Lumens	% Luminaire
Forward Light	10,389 lm	75.7%
0°-30°	1,564 lm	11.4%
30°-60°	5,381 lm	39.2%
60°-80°	3,320 lm	24.2%
80°-90°	124 lm	0.9%
Back Light	3,340 lm	24.3%
0°-30°	936 lm	6.8%
30°-60°	1,649 lm	12.0%
60°-80°	710 lm	5.2%
80°-90°	45 lm	0.3%
Up Light	0 lm	0.0%
90°-100°	0 lm	0.0%
100°-180°	0 lm	0.0%

BUG* Rating	
Asymmetrical Luminaire Types	
Type I, II, III, IV	B2 U0 G2
Quadrilateral Symmetrical Luminaire Types	
Type V, Area Light	B2 U0 G2

* Backlight, Uplight, Glare

PHOTOMETRIC SPECIFICATIONS (TYPE 2 [III])

ISOCANDELA PLOT

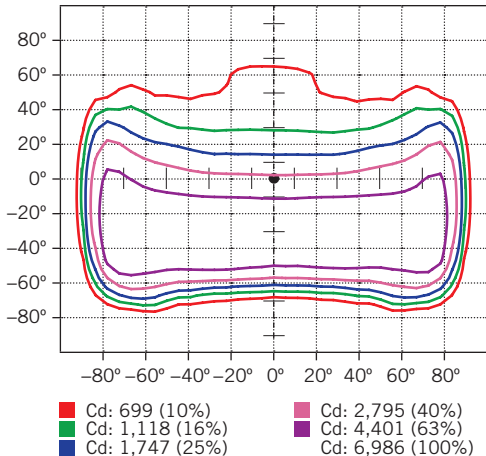

LUMINOUS INTENSITY DISTRIBUTION

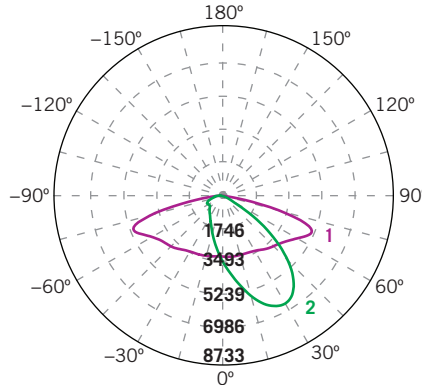

Average diffuse angle (50%): **104.0°**
1 Violet C0-C180
2 Green C90-C270
 Unit: cd

FLUX DISTRIBUTION

Zone	Lumens	% Luminaire
Forward Light	10,740 lm	76.2%
0°-30°	2,026 lm	14.4%
30°-60°	6,008 lm	42.6%
60°-80°	2,578 lm	18.3%
80°-90°	128 lm	0.9%
Back Light	3,347 lm	23.8%
0°-30°	846 lm	6.0%
30°-60°	1,524 lm	10.8%
60°-80°	914 lm	6.5%
80°-90°	63 lm	0.5%
Up Light	0 lm	0.0%
90°-100°	0 lm	0.0%
100°-180°	0 lm	0.0%

BUG* Rating	
Asymmetrical Luminaire Types	
Type I, II, III, IV	B2 U0 G2
Quadrilateral Symmetrical Luminaire Types	
Type V, Area Light	B2 U0 G2

* Backlight, Uplight, Glare

















KT-ALED100-S1-X-NM-8XX-VDIM

LED AREA LIGHT FIXTURES

EPA SPECIFICATIONS

Small-Size Fixture Housing

Conditions: Horizontal winds only for calculations. Worst case total projected area used for calculations. All drag coefficients are set as worst case 1.2. For details on exact EPA calculations and assumptions, please contact productsupport@keystonetech.com

EPA Calcs (1.2*ft^2 View)		Single Fixture	2 Fixtures at 90°	2 Fixtures at 180°	3 Fixtures at 90°	3 Fixtures at 120°	4 Fixtures at 90°	2 Fixtures Side-by-Side	3 Fixtures Side-by-Side	4 Fixtures Side-by-Side
Mounting Application	Fixture Position									
Adjustable Pole Mount 	Horizontal	0.50 sq. ft.	0.73 sq. ft.	1.00 sq. ft.	1.17 sq. ft.	1.21 sq. ft.	1.17 sq. ft.	0.56 sq. ft.	0.85 sq. ft.	1.13 sq. ft.
Adjustable Pole Mount 	45°	0.93 sq. ft.	1.41 sq. ft.	1.00 sq. ft.	1.89 sq. ft.	2.57 sq. ft.	1.89 sq. ft.	1.86 sq. ft.	2.78 sq. ft.	3.71 sq. ft.
Slip Fitter Mount 	Horizontal	0.48 sq. ft.	0.81 sq. ft.	0.96 sq. ft.	1.28 sq. ft.	1.31 sq. ft.	1.28 sq. ft.	0.69 sq. ft.	1.04 sq. ft.	1.38 sq. ft.
Slip Fitter Mount 	45°	1.00 sq. ft.	1.48 sq. ft.	1.00 sq. ft.	1.94 sq. ft.	2.63 sq. ft.	1.96 sq. ft.	2.00 sq. ft.	3.00 sq. ft.	4.00 sq. ft.
Slip Fitter Mount 	Vertical	1.32 sq. ft.	1.79 sq. ft.	1.32 sq. ft.	2.27 sq. ft.	2.70 sq. ft.	2.27 sq. ft.	2.64 sq. ft.	3.95 sq. ft.	5.27 sq. ft.



KT-ALED100-S1-X-NM-8XX-VDIM

LED AREA LIGHT FIXTURES

ACCESSORIES (SOLD SEPARATELY)

TWIST-LOCK AREA LIGHT CONTROL

Catalog Number	Description	UPC	Easy Code
KT-TLP-UV-3PN	NEMA Type Twist-Lock 3-Pin Photocell 120-277V, 1800VA Max; Blue Housing	843654131825	NQT-46



GLARE SHIELD

Catalog Number	Description	UPC	Easy Code
KT-ALED-GS-S1-KIT	Reversible Glare Shield Kit, Small; Fits "S1" fixture bodies; Bronze	843654131795	UAZ-87

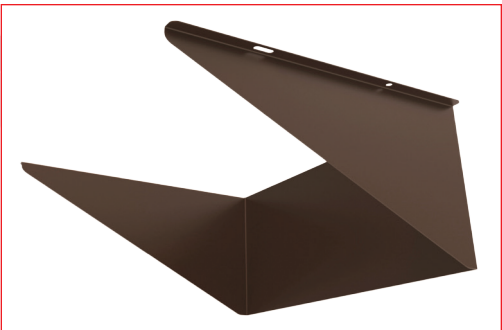

MICROWAVE OCCUPANCY SENSOR

Catalog Number	Description	UPC	Easy Code
KTS-MW3-12V-PKO	12V Microwave Occupancy Sensor	843654130637	TRM-32



REMOTE CONTROL

Catalog Number	Description	UPC	Easy Code
KTS-MW3-REMOTECONTROL	Remote Control for KTS-MW3-12V-XX Sensors, Sets/adjusts all sensor performance parameters	843654132020	XSR-61





KT-ALED100-S1-X-NM-8XX-VDIM

LED AREA LIGHT FIXTURES

ORDERING INFORMATION

ORDER CODE	PACK QTY.	UPC	Easy Code
KT-ALED100-S1-3-NM-840-VDIM	1	843654131368	RMZ-83
KT-ALED100-S1-3-NM-850-VDIM	1	843654131375	APN-42
KT-ALED100-S1-5-NM-840-VDIM	1	843654131382	AVF-23
KT-ALED100-S1-5-NM-850-VDIM	1	843654131399	ZCF-38

CATALOG NUMBER BREAKDOWN

KT-ALED100-S1-X-NM-8XX-VDIM

1	2	3	4	5	6	7	8	9	10	11	12	13
1 Keystone Technologies	2 Fixture Type	3 LED Technology	4 Wattage	5 Size/Shape	6 Style/Design Designation	7 Distribution Type	8 Mounting	9 CRI	10 Color Temp	11 Dimming	12 Housing Color	13 Options
	A Area Light			S Small	1 Series 1	2 Type 2 (II)	NM No Mounting	8 >80	40 4000K 50 5000K	VDIM 0-10V	Blank Bronze B Black W White	Blank No Options /7PRS 7-Pin Receptacle and Shorting Cap installed /MW3 Factory-installed Microwave Sensor