



LED LUMINAIRES



ProLED® Select Slim Downlight Series



The ProLED® Select Slim Downlight Series provides a high performing, ultra-slim, modern solution for new construction and retrofit downlighting projects. It offers the ability to select between 5 color temperatures which essentially reduces 30 products down to just 6 SKU's. This innovative product is available in both round and square, 4 inch and 6 inch housings with three different lumen outputs to make this one of the most versatile residential downlights on the market.



**Five Selectable
Color Temperatures**

**90+ CRI for Superior
Color Rendering**

**Wet Location Rated for
Greater Application Flexibility**

Low Profile Design

Dimmable to 10%

Applications:

- Homes
- Healthcare
- Office
- Retail
- Hospitality

Markets:

- Residential
- Light Commercial



Contact Your Customer Care Specialist
For Pricing, Orders And Technical Support.
800.677.3334 www.halcolighting.com

ProLED® Select Slim Downlight Series

Product #: _____ Type: _____

Project: _____ Date: _____

Comments: _____ Initials: _____

Performance

- 5 Field Selectable Color Temperatures (Cct)
- Provides Uniform Diffused Light
- Low Glare
- High Cri - 90+
- L70 Lumen Maintenance > 50,000 Hours
- 5 Year Limited Warranty
- Dimmable To 10%
- 120vac Input

Construction

- Simple installation - no additional housing or junction box required
- Low profile design and remote driver enclosure ideal for shallow plenums
- Spring loaded universal mounting slips ensure secure fit to ceiling
- IC rated steel junction box w/ (2) 3/4" knockouts
- Robust die cast aluminum construction
- Color select dip switch on driver enclosure
- 12" Cable connector between led module and driver compartment

| Dimmer Compatibility List | |
|---------------------------|----------------|
| Lutron | DVCL-153PR-WH |
| Lutron | CTCL-153PDH-WH |
| Lutron | TGCL-153PH-WH |
| Lutron | MACL-153MH-WH |
| Lutron | P-PKG1W-WH-R |
| Leviton | R62-06674-POW |
| Leviton | R12-06672-1LW |
| Leviton | R50-IPL06-10M |
| Eaton | AALO6-C1 |
| Eaton | SALO6P-LA-K |

Ordering Information

| Product Code | Product Number | Product Description |
|-----------------------|----------------|---|
| FSDLS4FR10/CCT/LED | 89093 | Field Selectable Slim Downlight 4" 10W 2700K-5000K Dimmable JA-8 ProLED Select |
| FSDLS6FR12/CCT/LED | 89094 | Field Selectable Slim Downlight 6" 12W 2700K-5000K Dimmable JA-8 ProLED Select |
| FSDLS6FR15/CCT/LED | 89095 | Field Selectable Slim Downlight 6" 15W 2700K-5000K Dimmable JA-8 ProLED Select |
| FSDLS4FR10/SQ/CCT/LED | 89096 | Field Selectable Square Slim Downlight 4" 10W 2700K-5000K Dimmable JA-8 ProLED Select |
| FSDLS6FR12/SQ/CCT/LED | 89097 | Field Selectable Square Slim Downlight 6" 12W 2700K-5000K Dimmable JA-8 ProLED Select |
| FSDLS6FR15/SQ/CCT/LED | 89098 | Field Selectable Square Slim Downlight 6" 15W 2700K-5000K Dimmable JA-8 ProLED Select |

Accessories

| Product Code | Product Number | Product Description |
|--------------|----------------|---|
| FSDLS/EXT12 | 89102 | Select Slim Downlight Extension Cable 12" |
| DLS/FK4RD | 89087 | Slim Downlight New Construction Frame - 4" Round |
| DLS/FK4SQ | 89088 | Slim Downlight New Construction Frame - 4" Square |
| DLS/FK6RD | 89089 | Slim Downlight New Construction Frame - 6" Round |
| DLS/FK4SQ | 89090 | Slim Downlight New Construction Frame - 6" Square |

Specifications

| Product Code | 4" | 6" (Standard) | 6" (High Lumen) |
|---------------------|---------------------------|---------------|-----------------|
| Rated Wattage | 10 | 12 | 15 |
| Delivered Lumens | 750 | 900 | 1100 |
| CCT | Selectable - 5 CCT | | |
| Input Voltage | 120VAC | | |
| Power Factor | >0.9 | | |
| L70 Lifetime | 50,000 | | |
| Efficacy | 75LPW | 75LPW | 74LPW |
| CRI | >90 | | |
| Dimming | 120V to 10% | | |
| Warranty | 5 years Standard | | |
| Environment | UL Wet Location, IC Rated | | |
| Ambient Temp Rating | -20°C - 40°C | | |
| Weight (lbs) | 0.89 | 1.23 | 1.23 |

ProLED® Select Slim Downlight Series

Product #: _____ Type: _____

Project: _____ Date: _____

Comments: _____ Initials: _____

Dimensions

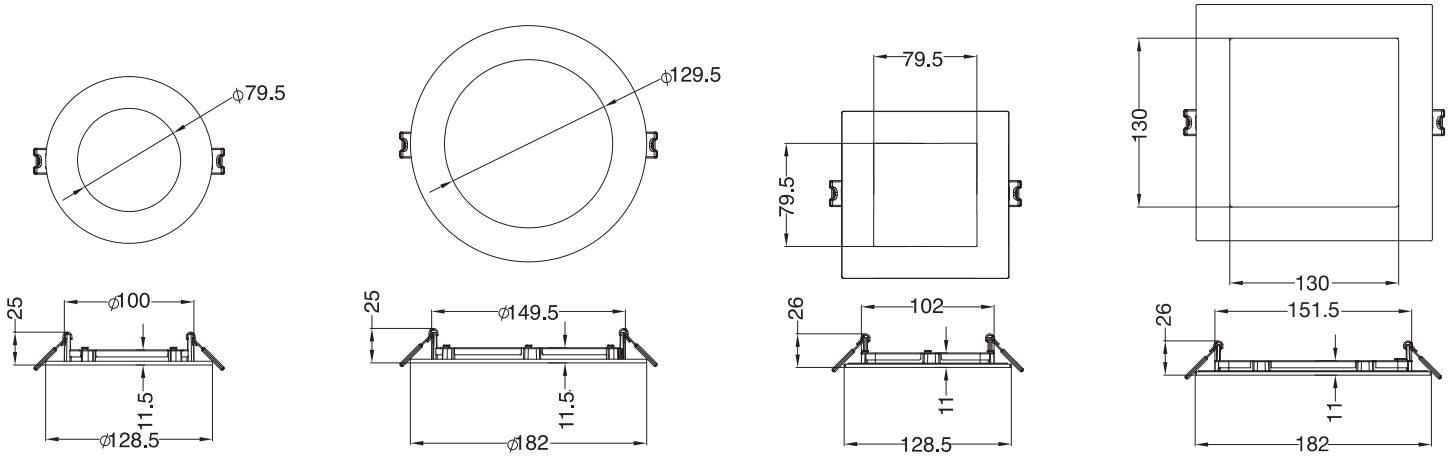

Photometrics

FSDLS4FR10/CCT/LED 89093

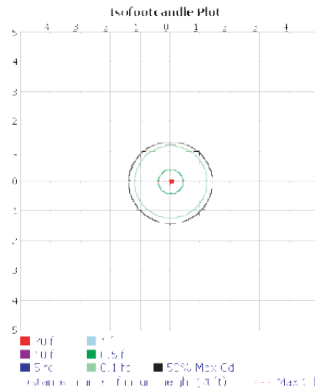
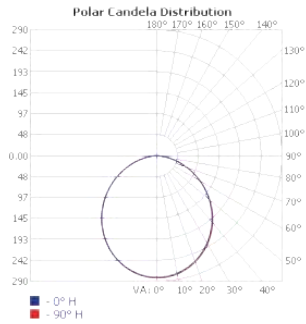

| LUMENS PER ZONE | | | |
|-----------------|--------|---------|---------------------|
| ZONE | LUMENS | % TOTAL | ZONE LUMENS % TOTAL |
| 0-10 | 26.5 | 3.5% | 90-100 0.000 0% |
| 10-20 | 75.6 | 10.0% | 100-110 0.000 0% |
| 20-30 | 113.4 | 14.9% | 110-120 0.000 0% |
| 30-40 | 134.9 | 17.8% | 120-130 0.000 0% |
| 40-50 | 137.4 | 18.1% | 130-140 0.000 0% |
| 50-60 | 121.3 | 16.0% | 140-150 0.000 0% |
| 60-70 | 89.7 | 11.8% | 150-160 0.000 0% |
| 70-80 | 49.2 | 6.5% | 160-170 0.000 0% |
| 80-90 | 10.9 | 1.4% | 170-180 0.000 0% |

| ZONAL LUMEN SUMMARY | | | |
|---------------------|--------|--------|-------------|
| ZONE | LUMENS | % LAMP | % LUMINAIRE |
| 0-30 | 215.5 | 28.4% | 28.4% |
| 0-40 | 350.4 | 46.2% | 46.2% |
| 0-60 | 609.2 | 80.3% | 80.3% |
| 60-90 | 149.8 | 19.7% | 19.7% |
| 70-100 | 60.1 | 7.9% | 7.9% |
| 90-120 | 0.000 | 0% | 0% |
| 0-90 | 759.0 | 100% | 100% |
| 90-180 | 0.000 | 0% | 0% |
| 0-180 | 759.0 | 100% | 100% |

FSDLS6FR12/CCT/LED 89094

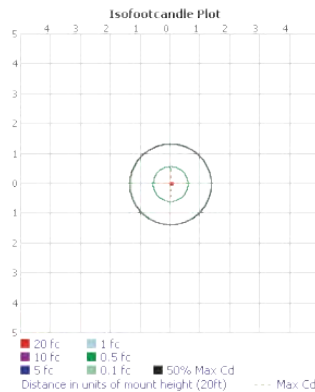
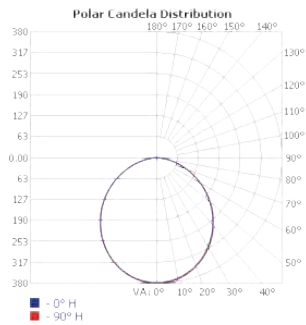

| LUMENS PER ZONE | | | |
|-----------------|--------|---------|---------------------|
| ZONE | LUMENS | % TOTAL | ZONE LUMENS % TOTAL |
| 0-10 | 35.7 | 3.5% | 90-100 0.000 0% |
| 10-20 | 101.6 | 10.0% | 100-110 0.000 0% |
| 20-30 | 152.2 | 15.0% | 110-120 0.000 0% |
| 30-40 | 180.6 | 17.8% | 120-130 0.000 0% |
| 40-50 | 183.5 | 18.1% | 130-140 0.000 0% |
| 50-60 | 161.5 | 15.9% | 140-150 0.000 0% |
| 60-70 | 119.0 | 11.7% | 150-160 0.000 0% |
| 70-80 | 65.0 | 6.4% | 160-170 0.000 0% |
| 80-90 | 14.4 | 1.4% | 170-180 0.000 0% |

| ZONAL LUMEN SUMMARY | | | |
|---------------------|---------|--------|-------------|
| ZONE | LUMENS | % LAMP | % LUMINAIRE |
| 0-30 | 289.5 | 28.6% | 28.6% |
| 0-40 | 470.1 | 46.4% | 46.4% |
| 0-60 | 815.1 | 80.4% | 80.4% |
| 60-90 | 198.5 | 19.6% | 19.6% |
| 70-100 | 79.4 | 7.8% | 7.8% |
| 90-120 | 0.001 | 0% | 0% |
| 0-90 | 1,013.6 | 100% | 100% |
| 90-180 | 0.001 | 0% | 0% |
| 0-180 | 1,013.6 | 100% | 100% |

ProLED® Select Slim Downlight Series

Photometrics

Product #: _____ Type: _____

Project: _____ Date: _____

Comments: _____ Initials: _____

FSDLS6FR15/CCT/LED 89095

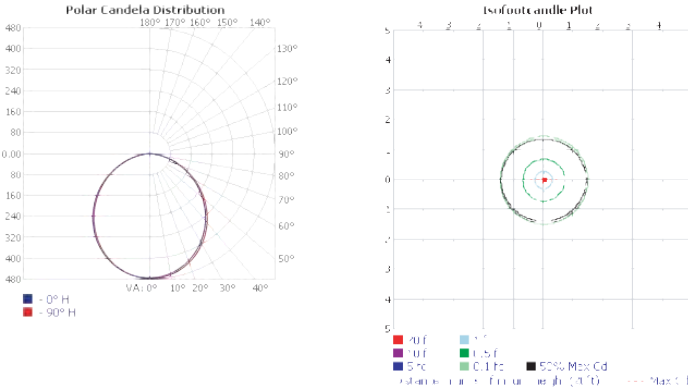

| LUMENS PER ZONE | | | |
|-----------------|--------|---------|---------------------|
| ZONE | LUMENS | % TOTAL | ZONE LUMENS % TOTAL |
| 0-10 | 44.8 | 3.5% | 90-100 0.000 0% |
| 10-20 | 127.8 | 10.0% | 100-110 0.000 0% |
| 20-30 | 191.7 | 14.9% | 110-120 0.000 0% |
| 30-40 | 228.0 | 17.8% | 120-130 0.000 0% |
| 40-50 | 232.3 | 18.1% | 130-140 0.000 0% |
| 50-60 | 205.1 | 16.0% | 140-150 0.000 0% |
| 60-70 | 151.8 | 11.8% | 150-160 0.000 0% |
| 70-80 | 83.5 | 6.5% | 160-170 0.000 0% |
| 80-90 | 19.0 | 1.5% | 170-180 0.000 0% |

| ZONAL LUMEN SUMMARY | | |
|---------------------|---------|--------------------|
| ZONE | LUMENS | % LAMP % LUMINAIRE |
| 0-30 | 364.3 | 28.4% |
| 0-40 | 592.3 | 46.1% |
| 0-60 | 1,029.7 | 80.2% |
| 60-90 | 254.3 | 19.8% |
| 70-100 | 102.5 | 8% |
| 90-120 | 0.000 | 0% |
| 0-90 | 1,284.0 | 100% |
| 90-180 | 0.000 | 0% |
| 0-180 | 1,284.0 | 100% |

FSDLS4FR10/SQ/CCT/LED 89096

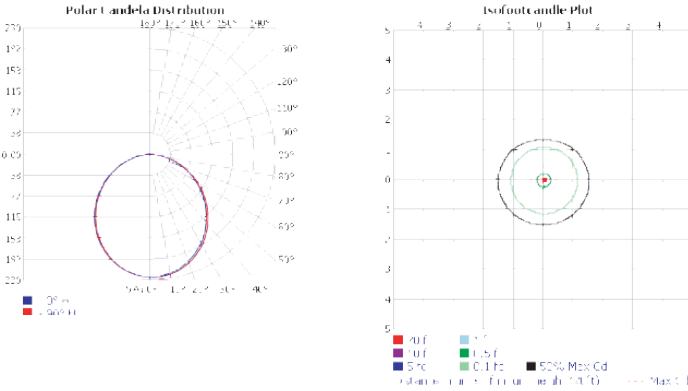

| LUMENS PER ZONE | | | |
|-----------------|--------|---------|---------------------|
| ZONE | LUMENS | % TOTAL | ZONE LUMENS % TOTAL |
| 0-10 | 21.1 | 3.4% | 90-100 0.0 0% |
| 10-20 | 60.2 | 9.7% | 100-110 0.0 0% |
| 20-30 | 90.6 | 14.5% | 110-120 0.0 0% |
| 30-40 | 108.0 | 17.3% | 120-130 0.0 0% |
| 40-50 | 110.8 | 17.8% | 130-140 0.0 0% |
| 50-60 | 99.2 | 15.9% | 140-150 0.0 0% |
| 60-70 | 75.7 | 12.1% | 150-160 0.0 0% |
| 70-80 | 44.7 | 7.2% | 160-170 0.0 0% |
| 80-90 | 12.5 | 2.0% | 170-180 0.004 0% |

| ZONAL LUMEN SUMMARY | | |
|---------------------|--------|--------------------|
| ZONE | LUMENS | % LAMP % LUMINAIRE |
| 0-30 | 171.9 | 27.6% |
| 0-40 | 279.9 | 44.9% |
| 0-60 | 490.0 | 78.6% |
| 60-90 | 133.0 | 21.3% |
| 70-100 | 57.3 | 9.2% |
| 90-120 | 0.1 | 0% |
| 0-90 | 622.9 | 100% |
| 90-180 | 0.2 | 0% |
| 0-180 | 623.2 | 100% |

FSDLS6FR12/SQ/CCT/LED 89097

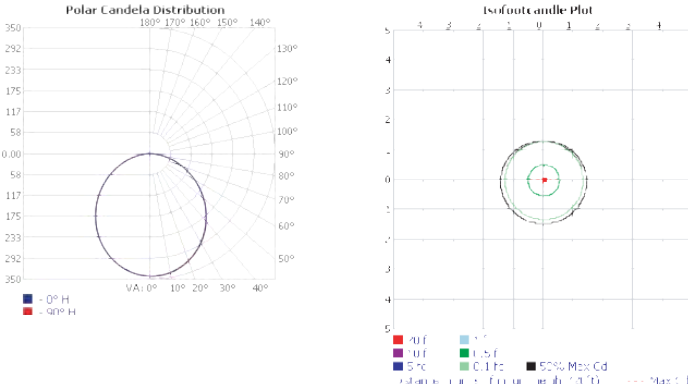

| LUMENS PER ZONE | | | |
|-----------------|--------|---------|---------------------|
| ZONE | LUMENS | % TOTAL | ZONE LUMENS % TOTAL |
| 0-10 | 32.2 | 3.4% | 90-100 0.0 0% |
| 10-20 | 91.6 | 9.8% | 100-110 0.0 0% |
| 20-30 | 137.3 | 14.7% | 110-120 0.0 0% |
| 30-40 | 163.1 | 17.4% | 120-130 0.0 0% |
| 40-50 | 166.4 | 17.8% | 130-140 0.0 0% |
| 50-60 | 148.0 | 15.8% | 140-150 0.0 0% |
| 60-70 | 112.1 | 12.0% | 150-160 0.0 0% |
| 70-80 | 65.8 | 7.0% | 160-170 0.0 0% |
| 80-90 | 18.2 | 1.9% | 170-180 0.004 0% |

| ZONAL LUMEN SUMMARY | | |
|---------------------|--------|--------------------|
| ZONE | LUMENS | % LAMP % LUMINAIRE |
| 0-30 | 261.2 | 27.9% |
| 0-40 | 424.3 | 45.4% |
| 0-60 | 738.6 | 79% |
| 60-90 | 196.1 | 21% |
| 70-100 | 84.0 | 9% |
| 90-120 | 0.1 | 0% |
| 0-90 | 934.7 | 100% |
| 90-180 | 0.2 | 0% |
| 0-180 | 934.9 | 100% |

FSDLS6FR15/SQ/CCT/LED 89098

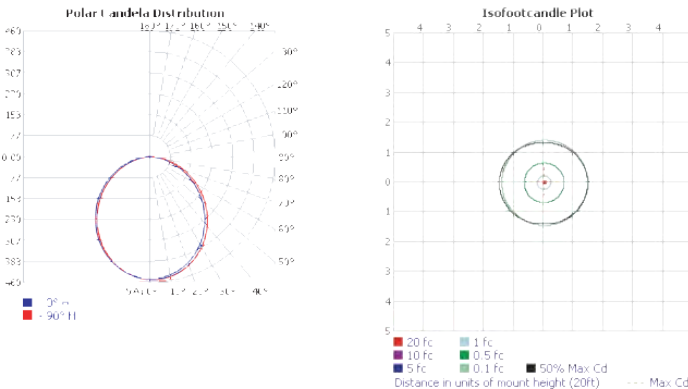

| LUMENS PER ZONE | | | |
|-----------------|--------|---------|---------------------|
| ZONE | LUMENS | % TOTAL | ZONE LUMENS % TOTAL |
| 0-10 | 42.2 | 3.5% | 90-100 0.2 0% |
| 10-20 | 120.0 | 9.9% | 100-110 0.0 0% |
| 20-30 | 179.4 | 14.8% | 110-120 0.0 0% |
| 30-40 | 212.5 | 17.5% | 120-130 0.0 0% |
| 40-50 | 216.0 | 17.8% | 130-140 0.0 0% |
| 50-60 | 191.5 | 15.8% | 140-150 0.0 0% |
| 60-70 | 144.5 | 11.9% | 150-160 0.0 0% |
| 70-80 | 84.2 | 6.9% | 160-170 0.0 0% |
| 80-90 | 23.7 | 2.0% | 170-180 0.006 0% |

| ZONAL LUMEN SUMMARY | | |
|---------------------|---------|--------------------|
| ZONE | LUMENS | % LAMP % LUMINAIRE |
| 0-30 | 341.6 | 28.1% |
| 0-40 | 554.1 | 45.6% |
| 0-60 | 961.6 | 79.2% |
| 60-90 | 252.4 | 20.8% |
| 70-100 | 108.1 | 8.9% |
| 90-120 | 0.2 | 0% |
| 0-90 | 1,214.0 | 100% |
| 90-180 | 0.4 | 0% |
| 0-180 | 1,214.4 | 100% |