

HBRE

Premium Round LED High Bay,
14,000 – 34,000 Lumens (100 – 240W)

Project:	
Type:	
Catalog #:	

STANDARD



FEATURES

- Available in 4000k (neutral white) and 5000k (cool white) color temperatures.*
- Long-life LEDs provide 174,000 hours of operation with at least 70% of initial lumen output (L₇₀).**
- Provides a range of 14,000 to 34,000 nominal lumens.*
- Universal 120-277 AC voltage (50-60Hz) and 6-foot incoming AC power cords are standard.
- 1-10vdc dimming drivers are standard.
- Watertight, compression-type electrical connectors.
- Mounting options include suspension from pre-installed mounting hook, yoke mounting, snap hook, and attachment to electrical conduit.
- Glass lens
- Power factor > 90.
- Total harmonic distortion < 20%.
- Color rendering index > 80.
- Die cast aluminum housing, painted black.
- Easy installation in new construction or retrofit.

* Contact factory for other color temperatures and lumen packages.

** L₇₀ hours are IES TM-21-11 calculated hours.



WARRANTY & LISTINGS

- cULus listed for wet locations in ambient temperatures from -30°C to 50°C (-22°F to 122°F).
- DLC premium approved.
- IP66 rated for ingress protection.
- Complies with FCC Part 15.
- Complies with EN61000-4-5, surge immunity protection (4kV).
- 5-year warranty of all electronics and housing.

MOUNTING OPTIONS

- Suspension from pre-installed mounting eyebolt with locking set screw is standard.
- Ceiling-mounted installation (using optional yoke mounting bracket, provides up to 180° of adjustability).
- Two ways to mount luminaire to electrical conduit:
 - Attach conduit (½" NPS) to optional yoke mounting bracket.
 - Optional pendant snap hook

DIMENSIONS

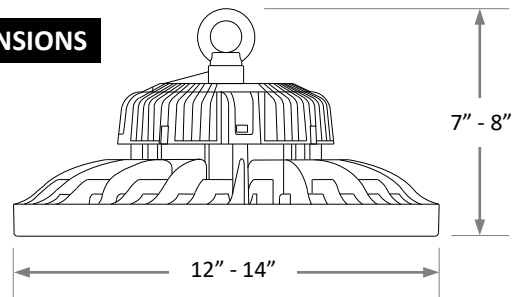

ORDERING INFORMATION

Example: HBRE-14L-5K

Model	Lumen Output		Color Temperature		Mounting Accessories (Order Separately)	
HBRE	14L	14,000	4K	4000k	LEDHBR SN-PSH-PRM-V2	Pendant snap hook
	21L	21,000	5K	5000k	HBRE-YOKE-S	Yoke mount bracket (14L-21L models)
	28L	28,000			LEDHBR SN-YOKE-PRM	Yoke mount bracket (28L-34L models)
	34L	34,000				

HBRE

Premium Round LED High Bay,
13,000 – 31,000 Lumens (100 – 240W)

MOUNTING OPTIONS

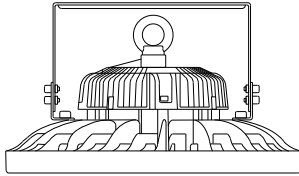

Ceiling-Mounted
(HBRE-YOKE-S)
(LEDHBRSN-YOKE-PRM)

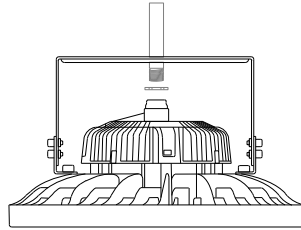

1/2" Conduit-Mounted
(HBRE-YOKE-S)
(LEDHBRSN-YOKE-PRM)

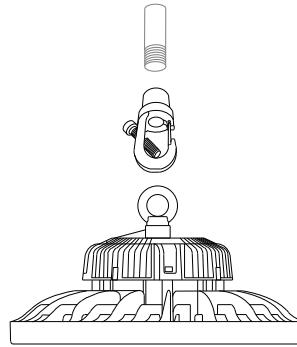

3/4" Conduit-Mounted
(LEDHBRSN-PSH-PRM-V2)

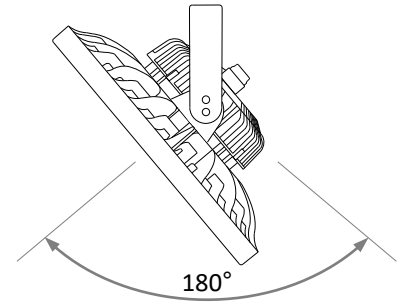

Adjustable

ELECTRICAL DATA

Model	Color Temperature	CRI ¹	Luminaire Lumens	Luminaire Watts	Lumens/Watt	Input Voltage ²	Input Current (A)			Power Factor	THD ³	L ₇₀ Hours ⁴
							120V	240V	277V			
HBRE-14L-4K	4000k	>80	14,497	102	142	120-277	0.85	0.43	0.37	>0.90	<20%	174,000
HBRE-14L-5K	5000k	>80	14,864	102	146	120-277	0.85	0.43	0.37	>0.90	<20%	174,000
HBRE-21L-4K	4000k	>80	20,859	150	139	120-277	1.25	0.63	0.54	>0.90	<20%	174,000
HBRE-21L-5K	5000k	>80	21,406	150	142	120-277	1.25	0.63	0.54	>0.90	<20%	174,000
HBRE-28L-4K	4000k	>80	28,341	200	141	120-277	1.67	0.83	0.72	>0.90	<20%	174,000
HBRE-28L-5K	5000k	>80	28,948	200	145	120-277	1.67	0.83	0.72	>0.90	<20%	174,000
HBRE-34L-4K	4000k	>80	33,552	241	139	120-277	2.00	1.00	0.87	>0.90	<20%	174,000
HBRE-34L-5K	5000k	>80	34,240	241	142	120-277	2.00	1.00	0.87	>0.90	<20%	174,000

¹ Color rendering index.

² All 50-60Hz.

³ Total harmonic distortion.

⁴ L₇₀ refers to the number of hours at which lumen output declines to 70% of the initial level. L₇₀ hours are IES TM-21-11 calculated hours.

PHOTOMETRIC DATA

HBRE-14L-4K (14,497 Lumens)

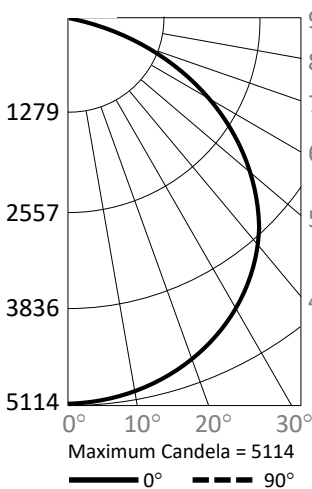

Candlepower Summary

	0°	90°
0°	5,114	5,114
10°	5,019	5,004
20°	4,789	4,783
30°	4,410	4,404
40°	3,864	3,855
50°	3,154	3,144
60°	2,224	2,194
70°	1,172	1,145
80°	279	252
90°	12	24

Zonal Lumen Summary

Zone	Lumens	% Fixture
0° – 10°	483	3.3%
0° – 20°	1,873	12.9%
0° – 30°	4,007	27.6%
0° – 40°	6,620	45.7%
0° – 50°	9,364	64.6%
0° – 60°	11,823	81.6%
0° – 70°	13,529	93.3%
0° – 80°	14,281	98.5%
0° – 90°	14,380	99.2%
90° – 180°	117	0.8%
0° – 180°	14,497	100.0%

Cone of Light

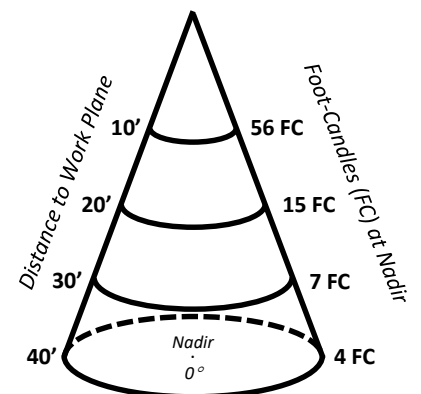

PHOTOMETRIC DATA

HBRE-21L-4K (20,859 Lumens)

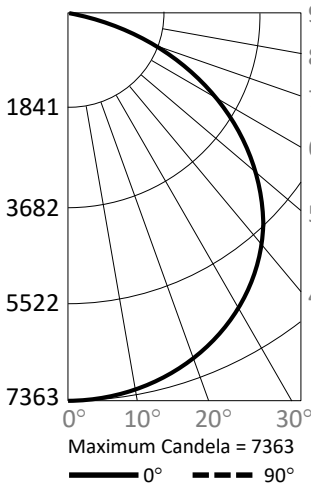

Candlepower Summary

	0°	90°
0°	7,363	7,363
10°	7,219	7,225
20°	6,907	6,916
30°	6,381	6,368
40°	5,589	5,593
50°	4,602	4,549
60°	3,296	3,198
70°	1,781	1,684
80°	451	371
90°	18	0

Zonal Lumen Summary

Zone	Lumens	% Fixture
0° – 10°	695	3.3%
0° – 20°	2698	12.9%
0° – 30°	5773	27.7%
0° – 40°	9536	45.7%
0° – 50°	13487	64.7%
0° – 60°	17028	81.6%
0° – 70°	19503	93.5%
0° – 80°	20610	98.8%
0° – 90°	20752	99.5%
90° – 180°	107	0.5%
0° – 180°	20,859	100.0%

Cone of Light

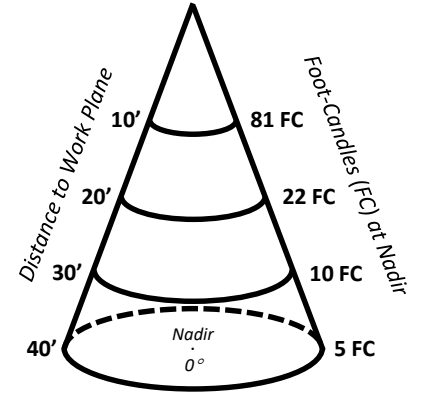

HBRE-28L-4K (28,341 Lumens)

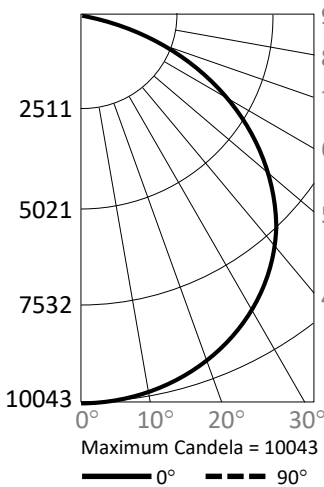

Candlepower Summary

	0°	90°
0°	10,043	10,043
10°	9,870	9,880
20°	9,435	9,460
30°	8,709	8,707
40°	7,644	7,650
50°	6,259	6,275
60°	4,528	4,532
70°	2,523	2,514
80°	670	634
90°	18	6

Zonal Lumen Summary

Zone	Lumens	% Fixture
0° – 10°	948	3.3%
0° – 20°	3,679	13.0%
0° – 30°	7,864	27.7%
0° – 40°	12,973	45.8%
0° – 50°	18,320	64.6%
0° – 60°	23,099	81.5%
0° – 70°	26,503	93.5%
0° – 80°	28,029	98.9%
0° – 90°	28,232	99.6%
90° – 180°	109	0.4%
0° – 180°	28,341	100.0%

Cone of Light

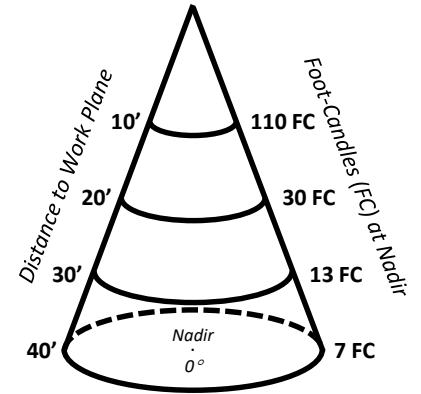

HBRE-34L-4K (33,552 Lumens)

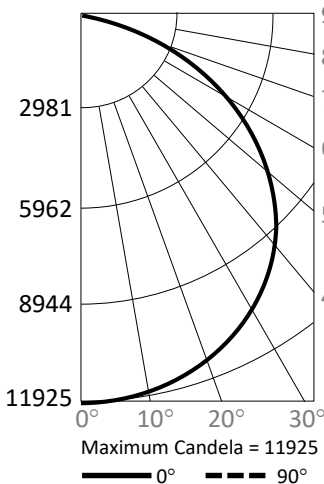

Candlepower Summary

	0°	90°
0°	11,925	11,925
10°	11,721	11,719
20°	11,195	11,183
30°	10,281	10,253
40°	8,994	8,978
50°	7,304	7,263
60°	5,236	5,143
70°	2,884	2,764
80°	775	680
90°	22	9

Zonal Lumen Summary

Zone	Lumens	% Fixture
0° – 10°	1,125	3.4%
0° – 20°	4,366	13.0%
0° – 30°	9,328	27.8%
0° – 40°	15,377	45.8%
0° – 50°	21,693	64.7%
0° – 60°	27,322	81.4%
0° – 70°	31,330	93.4%
0° – 80°	33,156	98.8%
0° – 90°	33,417	99.6%
90° – 180°	135	0.4%
0° – 180°	33,552	100.0%

Cone of Light

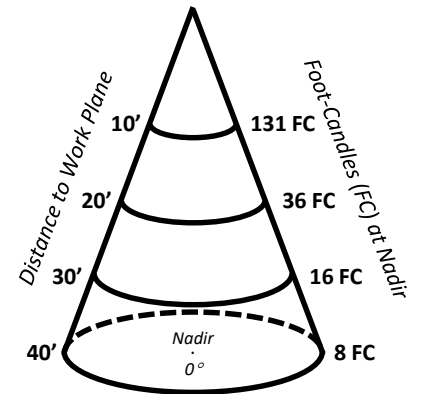

HBRE

Premium Round LED High Bay,
13,000 – 31,000 Lumens (100 – 240W)

PHOTOMETRIC DATA

HBRE-14L-4K (14,497 Lumens)

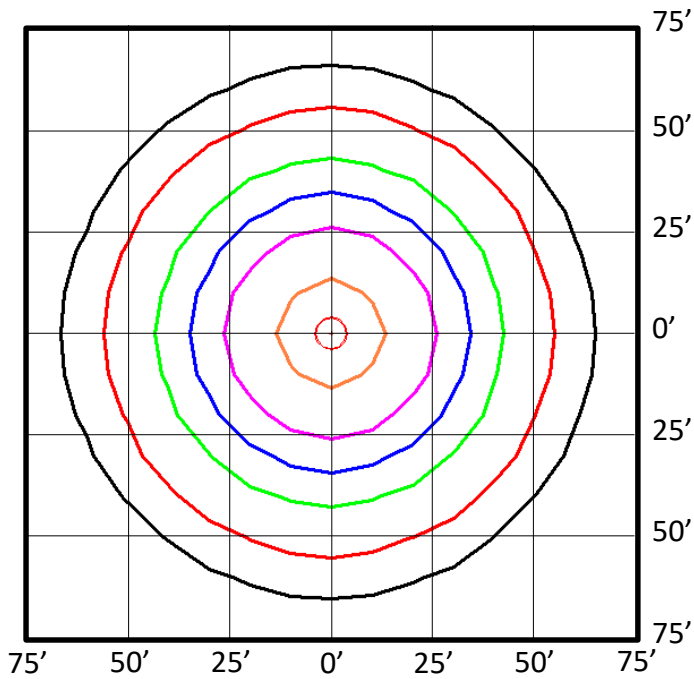

HBRE-21L-4K (20,859 Lumens)

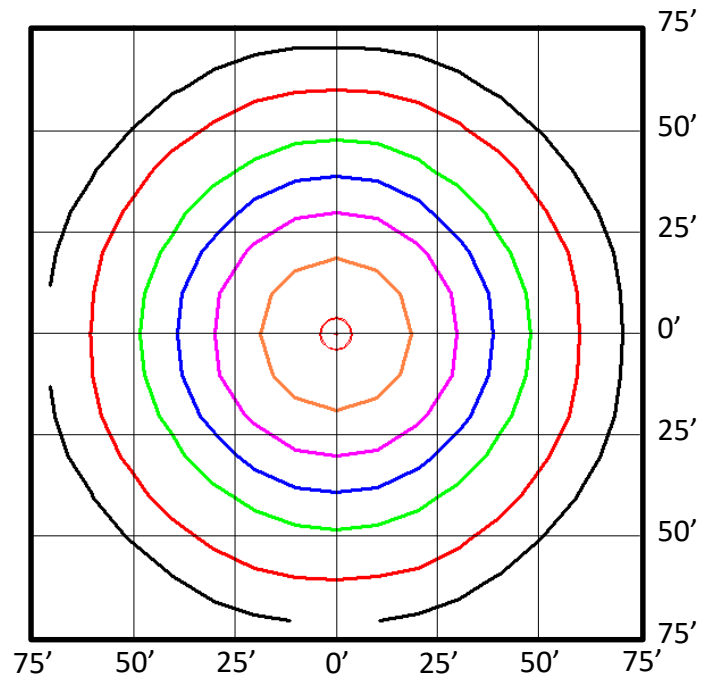

HBRE-28L-4K (28,341 Lumens)

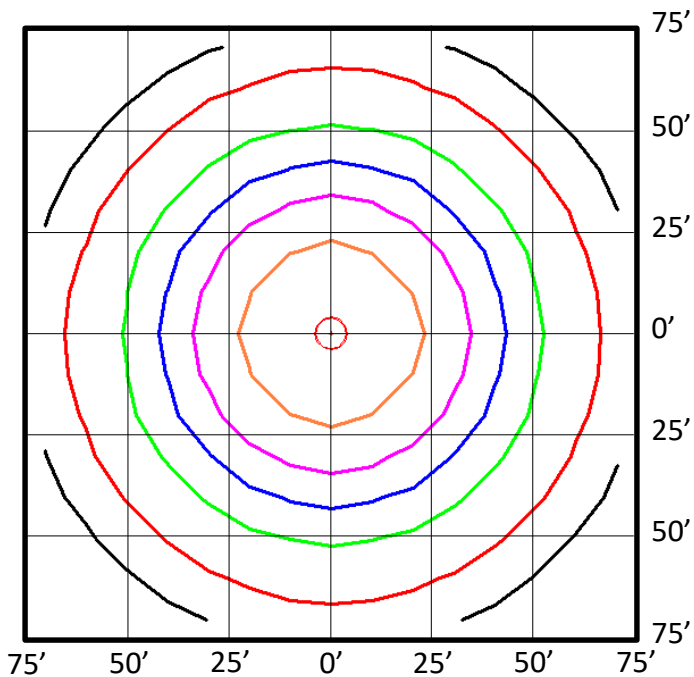

HBRE-34L-4K (33,552 Lumens)

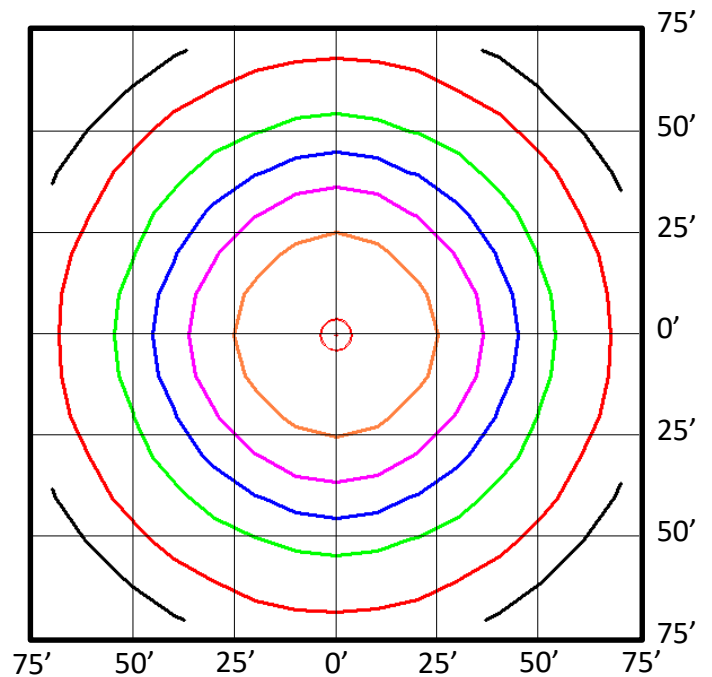

Foot Candles

- 5.0
- 2.0
- 1.0
- 0.5
- 0.2
- 0.1

Notes:

- Isofootcandle plots depict initial footcandles at grade.
- Gridlines represent units of mounting height of 25 feet.