

Project Name:	Type:
Part Number:	Date:

SPECFIT 6"

SPECIFICATION FEATURES

- **Mechanical** - SPECFIT retrofits existing commercial housings. Spring action clips to accommodate 1/2" to 2" ceiling thicknesses. Fixture with remote driver installs and is accessible from below the ceiling.
- **Electrical** - Standard driver option is 120-277V, 50/60 Hz with three selectable lumen outputs using SelectDrive technology. 0-10V dimmable to 5% with low end cutoff. 12V auxiliary port with stand by power functionality for additional dimming and control of field installed sensors and control systems. Additional driver selections include a 120V line voltage dimming option, Lutron Ecosystem 5% and 1% dimming driver options and a Philips EasySense sensor compatible driver option.
- **Optical** - Self flanged spun aluminum reflector. 45° optical cutoff. Field interchangeable optical lenses. Four beam distributions. Wall wash field installed accessory. COB LED binned to 3-step SDCM to ensure color uniformity in 2700K, 3000K, 3500K, 4000K or 5000K CCT. Minimum 90 CRI. 97 CRI with TRUE CHROMA available in 3000K only.
- **Thermal** - Die cast heat sink. L70 lifetime of 100,000 hours. Fixture operating temperature: -13°F to +95°F (-25°C to 35°C).
- **Compliance and Warranty** - ETL Classified and Listed for damp locations. 5 year parts warranty for complete fixture.



BENEFITS

- Get the right amount of light with SelectDrive technology
- Match ceiling décor with field interchangeable trims
- Direct the light with field interchangeable optics
- Various dimming driver options allow for control and energy savings
- Long 100,000 hours L70 rated lifetime

APPLICATIONS

- Commercial Office
- Hospitality
- Retail
- Educational
- Healthcare

DIMENSIONS

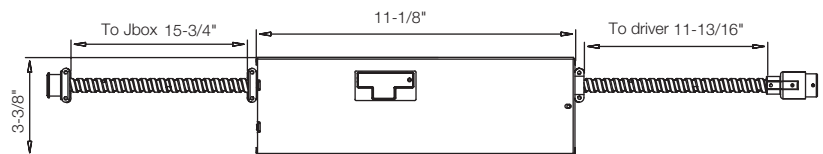
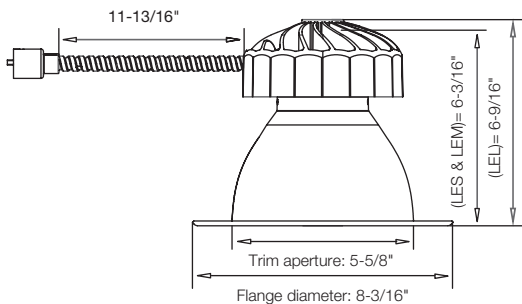

Minimum Ceiling Opening: 5-3/4" Maximum Ceiling Opening: 7-7/16"



SPECFIT 6"

ORDERING EXAMPLE

A complete fixture consists of one light engine and one reflector.

SelectDrive Light Engine: LEM9040DIM010UNVMD
Reflector: ADR6CC

SelectDrive Light Engines

Light Engine	CRI	CCT	Driver	Optical Distribution	Options ⁷
<input type="checkbox"/> LES Small Light Engine 500-700-1000 lumens	<input type="checkbox"/> 90 90+CRI	<input type="checkbox"/> 27 2700K	<input type="checkbox"/> DIM010UNV² SelectDrive 120-277V, 50/60Hz 0-10V Dimmable to 5%	<input type="checkbox"/> MD¹ Medium (Installed Standard) 60° Beam angle	<input type="checkbox"/> SD347 347V - 240V Step Down Transformer
<input type="checkbox"/> LEM Medium Light Engine 1500-2000-2500 lumens	<input type="checkbox"/> 97³ 97 CRI 3000K only	<input type="checkbox"/> 30 3000K		<input type="checkbox"/> VN Very Narrow 25° Beam angle	<input type="checkbox"/> SD480 480V - 240V Step Down Transformer
<input type="checkbox"/> LEL Large Light Engine 3000-4000-5000 lumens		<input type="checkbox"/> 35 3500K		<input type="checkbox"/> NR Narrow 40° Beam angle	<input type="checkbox"/> EM⁴ 10.7W Emergency Backup
		<input type="checkbox"/> 40 4000K		<input type="checkbox"/> WD Wide 75° Beam angle	<input type="checkbox"/> EM⁴ -CEC California Title 20 Compliant 10.7W Emergency Backup
		<input type="checkbox"/> 50 5000K			

Reflectors

Shape	Finish	
<input type="checkbox"/> ADR6 6" Round Reflector	<input type="checkbox"/> CC Clear Diffuse Trim and Flange	<input type="checkbox"/> WH Matte White Trim and Flange
	<input type="checkbox"/> CW Clear Diffuse Trim, White Flange	<input type="checkbox"/> BL Matte Black Trim and Flange

¹ Medium Lens Optic comes installed as standard, if other optic distribution selected the lens will ship separately and require field installation. / ² Dims to 5% with low end cutoff. Dimmer compatibility available on website. / ³ CRI97 TRUE CHROMA is only available in 3000K only and is not Energy Star rated. It is made to order (MTO) for the lumen values of 3000 and above, including the LEL light engine. / ⁴ EM cannot be combined with SD347 or SD480 option / ⁷ Options are factory installed and come with the Light Engine and Driver.

SPECFIT 6"

ORDERING EXAMPLE

A complete fixture consists of one light engine and one reflector.

Philips Light Engine W/ Enlighted Micro Sensor: LE259040PSRUNVWNENLS-IOT Reflector: ADR6CC	Philips Light Engine W/ EasySense Sensor: LE509030PSRUNVWNES Reflector: ADR6CW
120V Light Engine: LE209035DIM120VWD Reflector: ADR6BL	Lutron EcoSystem Light Engine: LE159027LUT5UNVNR Reflector: ADR6WH

ORDERING INFORMATION

Fixed Output Light Engines

Light Engine	CRI	CCT	Driver	Optical Distribution	Options ⁷
<input type="checkbox"/> LE05⁸ 500 lumens <input type="checkbox"/> LE07 700 lumens	<input type="checkbox"/> 90 90+CRI	<input type="checkbox"/> 27 2700K	<input type="checkbox"/> DIM120V 120V Dimmable, 120V	<input type="checkbox"/> MD¹ Medium (Installed Standard) 60° Beam angle	<input type="checkbox"/> SD347 347V - 240V Step Down Transformer
<input type="checkbox"/> LE10 1000 lumens <input type="checkbox"/> LE15 1500 lumens	<input type="checkbox"/> 97³ 97 CRI 3000K only	<input type="checkbox"/> 30 3000K	<input type="checkbox"/> PSRUNV 0-10V Driver + SR Ready Bridge, 120-277V	<input type="checkbox"/> VN Very Narrow 25° Beam angle	<input type="checkbox"/> SD480 480V - 240V Step Down Transformer
<input type="checkbox"/> LE20 2000 lumens <input type="checkbox"/> LE25 2500 lumens		<input type="checkbox"/> 35 3500K	<input type="checkbox"/> LUT-1UNV Lutron EcoSystem 1% Dimming, 120-277V	<input type="checkbox"/> NR Narrow 40° Beam angle	<input type="checkbox"/> EM⁴ 10.7W Emergency Backup
<input type="checkbox"/> LE30 3000 lumens <input type="checkbox"/> LE40 4000 lumens		<input type="checkbox"/> 40 4000K	<input type="checkbox"/> LUT-5UNV Lutron EcoSystem 5% Dimming, 120-277V	<input type="checkbox"/> WD Wide 75° Beam angle	<input type="checkbox"/> EM⁴ -CEC California Title 20 Compliant 10.7W Emergency Backup
<input type="checkbox"/> LE50⁹ 5000 lumens		<input type="checkbox"/> 50 5000K			<input type="checkbox"/> ES⁵ Philips EasySense ceiling mount sensor
					<input type="checkbox"/> ENLS⁶-IL Enlighted Two Wire ENLIGHTED ONE Compact Sensor
					<input type="checkbox"/> ENLS⁶-CL Enlighted Two Wire CONNECTED LIGHTING Compact Sensor
					<input type="checkbox"/> ENLS⁶-IOT Enlighted Two Wire IOT Compact Sensor





Reflectors

Shape	Finish
<input type="checkbox"/> ADR6 6" Round Reflector	<input type="checkbox"/> CC Clear Diffuse Trim and Flange <input type="checkbox"/> WH Matte White Trim and Flange
	<input type="checkbox"/> CW Clear Diffuse Trim, White Flange <input type="checkbox"/> BL Matte Black Trim and Flange

¹ Medium Lens Optic comes installed as standard, if other optic distribution selected the lens will ship separately and require field installation / ³ CRI97 TRUE CHROMA is only available in 3000K only and is not Energy Star rated. It is made to order (MTO) for the lumen values of 3000 and above, including the LEL light engine. / ⁴ EM cannot be combined with SD347 or SD480 option / ⁵ Philips EasySense ceiling mounted sensor is only available with the PSRUNV driver / ⁶ Enlighted Two Wire Compact Sensor with ceiling mount is only available with the PSRUNV driver. / ⁷ Options are factory installed and come with the Light Engine and Driver. / ⁸ LE05 is not available with LUT-5UNV / ⁹ LE50 is not available with LUT-5UNV and LUT-1UNV.

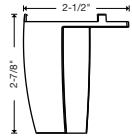

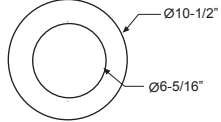
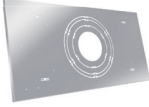
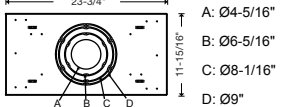
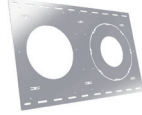
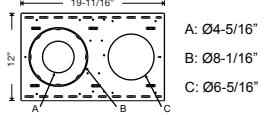
SPECFIT 6"

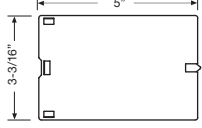
ACCESSORY ORDERING INFORMATION				
Product	Model	Description	Pictures	Dimensions
98079	ADWAW	Wall Wash (Field Installed on Module)		
98568	GOOFRING6	6" Goof Ring - Outer Diameter 10-1/2"		
98501	NCPLATE/T4689	New Construction Plate for T-Grid ceilings		 A: Ø4-5/16" B: Ø6-5/16" C: Ø8-1/16" D: Ø9"
98502	NCPLATE468	New Construction Plate for Stud/Joist ceilings		 A: Ø4-5/16" B: Ø8-1/16" C: Ø6-5/16"
98583	NCPLATEJB	Junction box for New Construction Plates		 3-3/16"



SPECFIT 6"

TECHNICAL INFORMATION

Light Engine	Input Voltage	Input Frequency	Input Current	Input Power	THD Power	Power Factor
LESXXXX	120 / 277V	50 / 60Hz	0.115 / 0.047A	13W	<20%	>0.9
LEMXXXX	120 / 277V	50 / 60Hz	0.270 / 0.114A	31.5W	<20%	>0.9
LELXXXX	120 / 277V	50 / 60Hz	0.530 / 0.217A	60W	<20%	>0.9
LE05XXXX	120 / 277V	50 / 60Hz	0.056 / 0.024A	6.5W	<20%	>0.9
LE07XXXX	120 / 277V	50 / 60Hz	0.073 / 0.034A	8.5W	<20%	>0.9
LE10XXXX	120 / 277V	50 / 60Hz	0.112 / 0.047A	13W	<20%	>0.9
LE15XXXX	120 / 277V	50 / 60Hz	0.154 / 0.068A	18W	<20%	>0.9
LE20XXXX	120 / 277V	50 / 60Hz	0.218 / 0.092A	25.5W	<20%	>0.9
LE25XXXX	120 / 277V	50 / 60Hz	0.269 / 0.116A	31.5W	<20%	>0.9
LE30XXXX	120 / 277V	50 / 60Hz	0.318 / 0.133A	37.5W	<20%	>0.9
LE40XXXX	120 / 277V	50 / 60Hz	0.411 / 0.165A	48.5W	<20%	>0.9
LE50XXXX	120 / 277V	50 / 60Hz	0.487 / 0.203A	57.5W	<20%	>0.9

NOMINAL PERFORMANCE

LES (LE05 / LE07 / LE10) - Low / Medium / High - 6.5 / 8.5 / 12.5W

CCT	2700K			3000K			3500K			4000K			5000K		
	Low	Medium	High	Low	Medium	High	Low	Medium	High	Low	Medium	High	Low	Medium	High
Output**	Im LPW	Im LPW	Im LPW	Im LPW	Im LPW	Im LPW	Im LPW	Im LPW	Im LPW	Im LPW	Im LPW	Im LPW	Im LPW	Im LPW	Im LPW
Finish	Im LPW	Im LPW	Im LPW	Im LPW	Im LPW	Im LPW	Im LPW	Im LPW	Im LPW	Im LPW	Im LPW	Im LPW	Im LPW	Im LPW	Im LPW
Clear Diffuse	500 77	700 82	1,000 80	525 81	735 86	1,050 84	550 85	770 91	1,100 88	575 88	805 95	1,150 92	580 89	810 95	1,165 93
White	495 76	693 82	990 79	520 80	728 86	1,040 83	545 84	762 90	1,089 87	569 88	797 94	1,139 91	574 88	802 94	1,153 92
Black	440 68	616 72	880 70	462 71	647 76	924 74	484 74	678 80	968 77	506 78	708 83	1,012 81	510 78	714 84	1,015 81

LEM (LE15 / LE20 / LE25) - Low / Medium / High - 18.0 / 25.5 / 31.5W

CCT	2700K			3000K			3500K			4000K			5000K		
	Low	Medium	High	Low	Medium	High	Low	Medium	High	Low	Medium	High	Low	Medium	High
Output**	Im LPW	Im LPW	Im LPW	Im LPW	Im LPW	Im LPW	Im LPW	Im LPW	Im LPW	Im LPW	Im LPW	Im LPW	Im LPW	Im LPW	Im LPW
Finish	Im LPW	Im LPW	Im LPW	Im LPW	Im LPW	Im LPW	Im LPW	Im LPW	Im LPW	Im LPW	Im LPW	Im LPW	Im LPW	Im LPW	Im LPW
Clear Diffuse	1,600 89	2,125 83	2,500 79	1,632 91	2,169 85	2,550 81	1,664 92	2,210 87	2,600 83	1,696 94	2,253 88	2,650 84	1,713 95	2,275 89	2,677 85
White	1,584 88	2,104 82	2,475 78	1,616 90	2,147 84	2,525 80	1,647 91	2,188 86	2,574 82	1,679 93	2,230 87	2,624 83	1,696 94	2,252 88	2,650 84
Black	1,408 78	1,870 73	2,200 70	1,436 80	1,909 75	2,244 71	1,464 81	1,945 77	2,288 73	1,492 83	1,983 77	2,332 74	1,507 84	2,002 79	2,355 75

LEL (LE30 / LE40 / LE50) - Low / Medium / High - 37.5 / 48.5 / 60.0W

CCT	2700K			3000K			3500K			4000K			5000K		
	Low	Medium	High	Low	Medium	High	Low	Medium	High	Low	Medium	High	Low	Medium	High
Output**	Im LPW	Im LPW	Im LPW	Im LPW	Im LPW	Im LPW	Im LPW	Im LPW	Im LPW	Im LPW	Im LPW	Im LPW	Im LPW	Im LPW	Im LPW
Finish	Im LPW	Im LPW	Im LPW	Im LPW	Im LPW	Im LPW	Im LPW	Im LPW	Im LPW	Im LPW	Im LPW	Im LPW	Im LPW	Im LPW	Im LPW
Clear Diffuse	3,325 89	4,085 84	4,750 79	3,360 90	4,080 84	4,800 80	3,500 93	4,250 88	5,000 83	3,640 97	4,420 91	5,200 87	3,640 97	4,420 91	5,200 87
White	3,292 88	4,044 83	4,703 78	3,326 89	4,039 83	4,752 79	3,465 92	4,208 87	4,950 82	3,604 96	4,376 90	5,148 86	3,604 96	4,376 90	5,148 86
Black	2,826 78	3,472 71	4,038 67	2,856 77	3,468 71	4,080 68	2,975 79	3,613 75	4,250 71	3,094 82	3,757 77	4,420 74	2,829 75	3,757 77	4,420 74

** Lumen output are based on rated lumens, for exact value please refer to the IES files



SPECFIT 6"

PHOTOMETRY

LES9035-DIM010-UNV-VN-ADR6CC

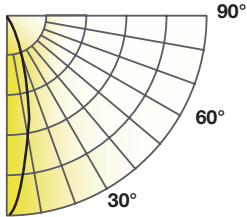

Lumens: 1,236 lm
Power: 12.7 W
Efficacy: 98 lm/W
CRI: 90+
Spacing Criteria: 0.4
Beam Angle: 25°

Candlepower Distribution		Initial Footcandles			Zonal Lumen Summary		
Angle (°)	Average (cd)	Height (ft)	Fc	Diameter (ft)	Zone	Lumens	%Fixt
10	2,603	4	278	2	0-30	1,139	93%
20	1,157	6	123	3	0-40	1,214	98%
30	293	8	69	4	0-60	1,234	100%
40	40	10	44	5	0-90	1,236	100%
50	6	12	31	5			
60	2						
70	1						
80	0						
90	0						

LES9035-DIM010-UNV-NR-ADR6CC

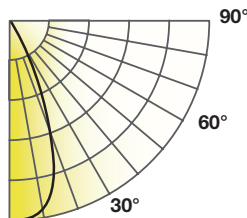

Lumens: 1,234 lm
Power: 12.5 W
Efficacy: 99 lm/W
CRI: 90+
Spacing Criteria: 0.7
Beam Angle: 43°

Candlepower Distribution		Initial Footcandles			Zonal Lumen Summary		
Angle (°)	Average (cd)	Height (ft)	Fc	Diameter (ft)	Zone	Lumens	%Fixt
10	2,233	4	141	3	0-30	1,111	93%
20	1,401	6	63	5	0-40	1,217	98%
30	456	8	35	6	0-60	1,233	100%
40	46	10	23	8	0-90	1,234	100%
50	5	12	16	9			
60	2						
70	1						
80	0						
90	0						

LES9035-DIM010-UNV-MD-ADR6CC

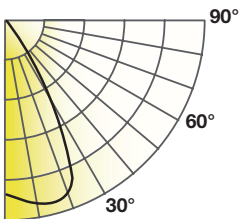

Lumens: 1,240 lm
Power: 12.2 W
Efficacy: 102 lm/W
CRI: 90+
Spacing Criteria: 0.9
Beam Angle: 64°

Candlepower Distribution		Initial Footcandles			Zonal Lumen Summary		
Angle (°)	Average (cd)	Height (ft)	Fc	Diameter (ft)	Zone	Lumens	%Fixt
10	1,317	8	80	4	0-30	965	74%
20	1,277	10	36	7	0-40	1,203	95%
30	755	12	20	9	0-60	1,237	100%
40	168	15	13	11	0-90	1,240	100%
50	8	20	9	13			
60	2						
70	1						
80	0						
90	0						



SPECFIT 6"

PHOTOMETRY

LES9035-DIM010-UNV-WD-ADR6CC

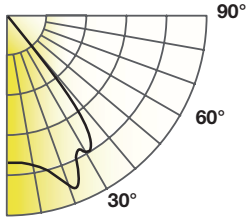

Lumens: 1,257 lm
Power: 12.28 W
Efficacy: 102.33 lm/W
CRI: 90+
Spacing Criteria: 1.2
Beam Angle: 43.3°

Candlepower Distribution		Initial Footcandles			Zonal Lumen Summary		
Angle (°)	Average (cd)	Height (ft)	Fc	Diameter (ft)	Zone	Lumens	%Fixt
10	1,153	4	56	6	0-30	663	53%
20	1,238	6	25	9	0-40	1120	89%
30	704	8	14	13	0-60	1251	100%
40	137	10	9	16	0-90	1257	100%
50	26	12	6	19			
60	6						
70	2						
80	0						
90	0						

LEM9035-DIM010-UNV-VN-ADR6CC

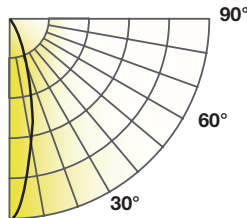

Lumens: 2,555 lm
Power: 30.9 W
Efficacy: 83 lm/W
CRI: 90+
Spacing Criteria: 0.4
Beam Angle: 25°

Candlepower Distribution		Initial Footcandles			Zonal Lumen Summary		
Angle (°)	Average (cd)	Height (ft)	Fc	Diameter (ft)	Zone	Lumens	%Fixt
10	5,592	4	607	2	0-30	2,364	93%
20	2,178	6	270	3	0-40	2,510	98%
30	635	8	152	3	0-60	2,539	100%
40	88	10	97	4	0-90	2,555	100%
50	12	12	67	5			
60	4						
70	1						
80	0						
90	0						

LEM9035-DIM010-UNV-NR-ADR6CC

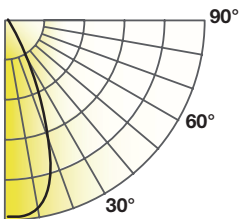

Lumens: 2,567 lm
Power: 31.1 W
Efficacy: 83 lm/W
CRI: 90+
Spacing Criteria: 0.7
Beam Angle: 41°

Candlepower Distribution		Initial Footcandles			Zonal Lumen Summary		
Angle (°)	Average (cd)	Height (ft)	Fc	Diameter (ft)	Zone	Lumens	%Fixt
10	4,978	8	302	3	0-30	2,332	91%
20	2,529	10	134	5	0-40	2,532	99%
30	920	12	76	6	0-60	2,562	100%
40	86	15	48	7	0-90	2,567	100%
50	11	20	34	9			
60	3						
70	1						
80	0						
90	0						



SPECFIT 6"

PHOTOMETRY

LEM9035-DIM010-UNV-MD-ADR6CC

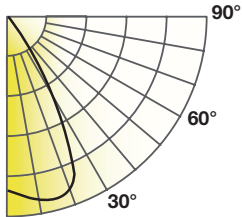

Lumens: 2,532 lm
Power: 30.9 W
Efficacy: 82 lm/W
CRI: 90+
Spacing Criteria: 0.9
Beam Angle: 65°

Candlepower Distribution		Initial Footcandles			Zonal Lumen Summary		
Angle (°)	Average (cd)	Height (ft)	Fc	Diameter (ft)	Zone	Lumens	%Fixt
10	2,493	4	164	4	0-30	1,957	77%
20	2,839	6	73	6	0-40	2,460	97%
30	1,555	8	41	8	0-60	2,526	100%
40	232	10	26	11	0-90	2,532	100%
50	13	12	18	13			
60	4						
70	2						
80	0						
90	0						

LEM9035-DIM010-UNV-WD-ADR6CC

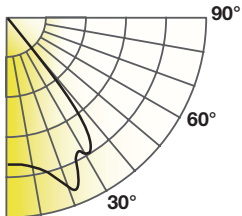

Lumens: 2,555 lm
Power: 31.0 W
Efficacy: 82 lm/W
CRI: 90+
Spacing Criteria: 1.2
Beam Angle: 83°

Candlepower Distribution		Initial Footcandles			Zonal Lumen Summary		
Angle (°)	Average (cd)	Height (ft)	Fc	Diameter (ft)	Zone	Lumens	%Fixt
10	1,508	4	113	6	0-30	1,289	50%
20	1,366	6	50	9	0-40	2,261	89%
30	2,064	8	28	13	0-60	2,543	100%
40	1,066	10	18	16	0-90	2,555	100%
50	45	12	13	19			
60	13						
70	5						
80	2						
90	0						

LEL9035-DIM010-UNV-VN-ADR6CC

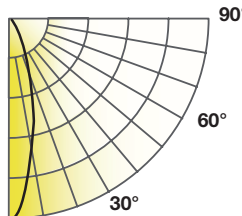

Lumens: 4,709 lm
Power: 60.7 W
Efficacy: 78 lm/W
CRI: 90+
Spacing Criteria: 0.5
Beam Angle: 33°

Candlepower Distribution		Initial Footcandles			Zonal Lumen Summary		
Angle (°)	Average (cd)	Height (ft)	Fc	Diameter (ft)	Zone	Lumens	%Fixt
10	813	8	176	5	0-30	4,118	88%
20	478	10	113	6	0-40	4,566	97%
30	204	12	78	7	0-60	4,687	100%
40	26	15	50	9	0-90	4,709	100%
50	5	20	28	12			
60	2						
70	1						
80	0						
90	0						



SPECFIT 6"

PHOTOMETRY

LEL9035-DIM010-UNV-NR-ADR6CC

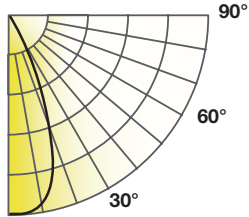

Lumens: 4,874 lm
Power: 61.1 W
Efficacy: 80 lm/W
CRI: 90+
Spacing Criteria: 0.7
Beam Angle: 44°

Candlepower Distribution		Initial Footcandles			Zonal Lumen Summary		
Angle (°)	Average (cd)	Height (ft)	Fc	Diameter (ft)	Zone	Lumens	%Fixt
10	7,615	8	145	7	0-30	4,182	86%
20	5,149	10	93	8	0-40	4,780	98%
30	2,134	12	64	10	0-60	4,858	100%
40	223	15	41	12	0-90	4,874	100%
50	33	20	23	16			
60	11						
70	5						
80	2						
90	0						

LEL9035-DIM010-UNV-MD-ADR6CC

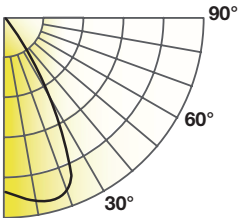

Lumens: 5,017 lm
Power: 60.59 W
Efficacy: 82.80 lm/W
CRI: 90+
Spacing Criteria: 0.78
Beam Angle: 54.7°

Candlepower Distribution		Initial Footcandles			Zonal Lumen Summary		
Angle (°)	Average (cd)	Height (ft)	Fc	Diameter (ft)	Zone	Lumens	%Fixt
10	5,967	4	105	8	0-30	3,691	74%
20	4,373	6	67	10	0-40	4,850	97%
30	3,080	8	47	12	0-60	5,000	100%
40	872	10	30	15	0-90	5,017	100%
50	41	12	17	20			
60	13						
70	5						
80	2						
90	0						

LEL9035-DIM010-UNV-WD-ADR6CC

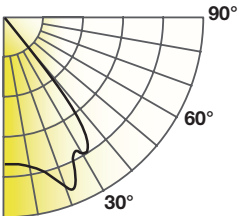

Lumens: 5,068 lm
Power: 60.6 W
Efficacy: 83 lm/W
CRI: 90+
Spacing Criteria: 1.1
Beam Angle: 74°

Candlepower Distribution		Initial Footcandles			Zonal Lumen Summary		
Angle (°)	Average (cd)	Height (ft)	Fc	Diameter (ft)	Zone	Lumens	%Fixt
10	3,860	8	63	12	0-30	3,107	61%
20	3,786	10	40	15	0-40	4,612	91%
30	3,355	12	28	18	0-60	5,038	99%
40	1,658	15	18	23	0-90	5,068	100%
50	99	20	10	30			
60	30						
70	12						
80	5						
90	0						



SPECFIT 6"

PHOTOMETRY - TRUE CHROMA

LES9730-DIM010-UNV-MD-ADR6CC

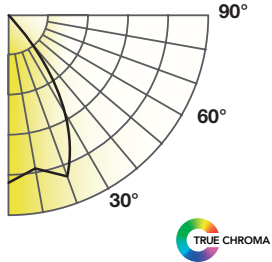

Lumens: 1,061 lm
 Power: 13 W
 Efficacy: 84 lm/W
 CRI: 96
 Spacing Criteria: 1.07
 Beam Angle: 65°

Candlepower Distribution		Initial Footcandles			Zonal Lumen Summary		
Angle (°)	Average (cd)	Height (ft)	Fc	Diameter (ft)	Zone	Lumens	%Fixt
10	1,012	4	94	5	0-30	761	72%
20	978	6	42	8	0-40	1,012	95%
30	643	8	24	10	0-60	1,061	100%
40	172	10	15	13	0-90	1,061	100%
50	5	12	10	15			
60	0						
70	0						
80	0						
90	0						

LEM9730-DIM010-UNV-MD-ADR6CC

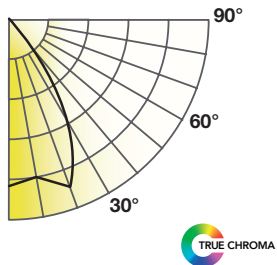

Lumens: 2,231 lm
 Power: 33 W
 Efficacy: 68 lm/W
 CRI: 96
 Spacing Criteria: 1.07
 Beam Angle: 65°

Candlepower Distribution		Initial Footcandles			Zonal Lumen Summary		
Angle (°)	Average (cd)	Height (ft)	Fc	Diameter (ft)	Zone	Lumens	%Fixt
10	2,129	4	198	5	0-30	1,595	72%
20	2,057	6	88	8	0-40	2,122	95%
30	1,357	8	49	10	0-60	2,229	100%
40	366	10	32	13	0-90	1,160	100%
50	8	12	22	15			
60	2						
70	0						
80	0						
90	0						

LEL9730-DIM010UNV-MD-ADR6CC

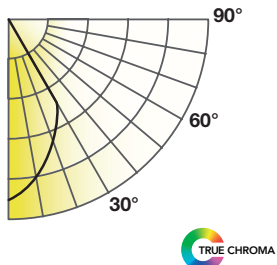

Lumens: 4,230 lm
 Power: 60W
 Efficacy: 71 lm/W
 CRI: 98
 Spacing Criteria: 0.79
 Beam Angle: 57°

Candlepower Distribution		Initial Footcandles			Zonal Lumen Summary		
Angle (°)	Average (cd)	Height (ft)	Fc	Diameter (ft)	Zone	Lumens	%Fixt
10	2,129	8	49	9	0-30	2,963	71%
20	2,057	10	32	11	0-40	4,027	95%
30	1,357	12	22	13	0-60	4,230	100%
40	366	15	14	16	0-90	4,230	100%
50	8	20	8	22			
60	2						
70	0						
80	0						
90	0						



SPECFIT 6"

COLOR ACCURACY & SPECTRAL DISTRIBUTION FOR 97 CRI WITH TRUE CHROMA

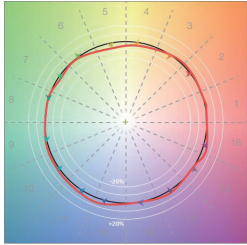
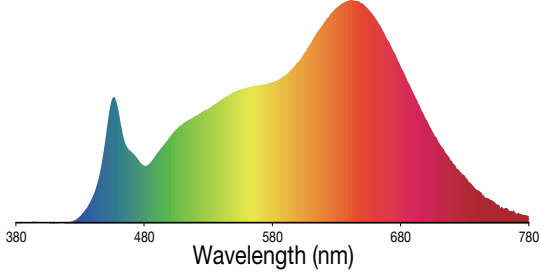
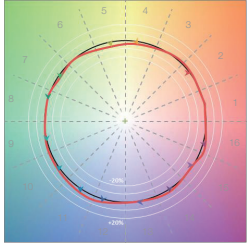
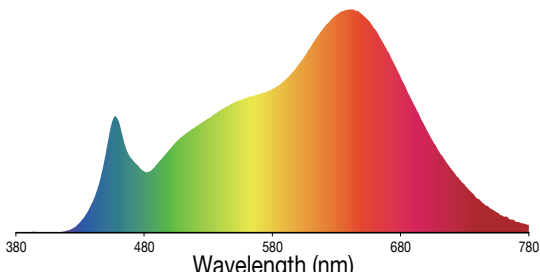
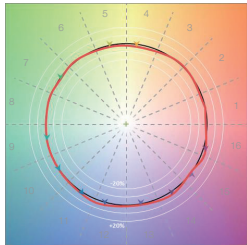
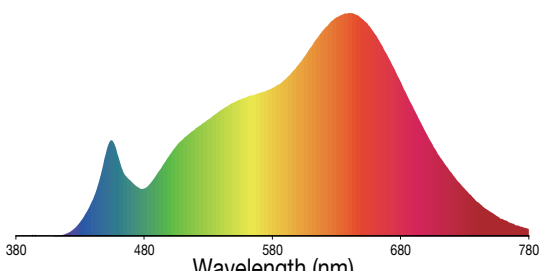

CCT	COLOR ACCURACY	SPECTRAL POWER DISTRIBUTION
LES9730DIM010UNVMD	 <p>Rr: 93, Rg: 101</p>	 <p>Wavelength (nm)</p>
LEM9730DIM010UNVMD	 <p>Rr: 94, Rg: 101</p>	 <p>Wavelength (nm)</p>
LEL9730DIM010UNVMD	 <p>Rr: 95, Rg: 101</p>	 <p>Wavelength (nm)</p>

Rf: TM-30 metric measuring color fidelity (whether colors are similar to those under natural light). Rf is a more accurate version of the CRI Ra. Rf is 100 for natural light.
 Rg: TM-30 metric measuring color gamut (whether colors are more saturated than under natural light). Rg is 100 for natural light.