

|               |       |
|---------------|-------|
| Project Name: | Type: |
| Part Number:  | Date: |

# 3N1 9" SURFACE MOUNT

## SPECIFICATION FEATURES

- **Mechanical** - Die cast aluminum heat sink. Polycarbonate trim. Smooth diffuse polycarbonate lens. Galvanized steel bracket mounts to industry standard 4" junction boxes from below the ceiling.
- **Electrical** - Universal 120-277V or 120V only, 50/60 Hz drivers available. Universal voltage, 0-10V drivers are dimmable to 5%. 120V drivers are dimmable to 10% using TRIAC or ELV dimmers.
- **Optical** - Edge lighting technology featuring a PMMA light guide plate and smooth polycarbonate lens ensures an even light emitting surface. 110° beam angle. Using SelectKelvin technology, field select color temperature between 3000K/3500K/4000K with a minimum of 90 CRI.
- **Thermal** - Die cast heat sink maximizes passive thermal management and achieves a L70 rated lifetime of 50,000 hours. Ambient temperature rated from -22°F to 95°F (-30°C to 35°C).
- **Compliance and Warranty** - ETL Classified and Listed for wet locations. Certified air-tight per ASTM 283-04. IC Rated for direct contact with insulation. Complies with FCC 47CFR Part 15B consumer limits for EMI/RFI emissions. Compliant with NFPA® 70, NEC® Section 410.16 (A)(3) and 410.16 (C)(5). 5 year parts warranty for complete fixture.

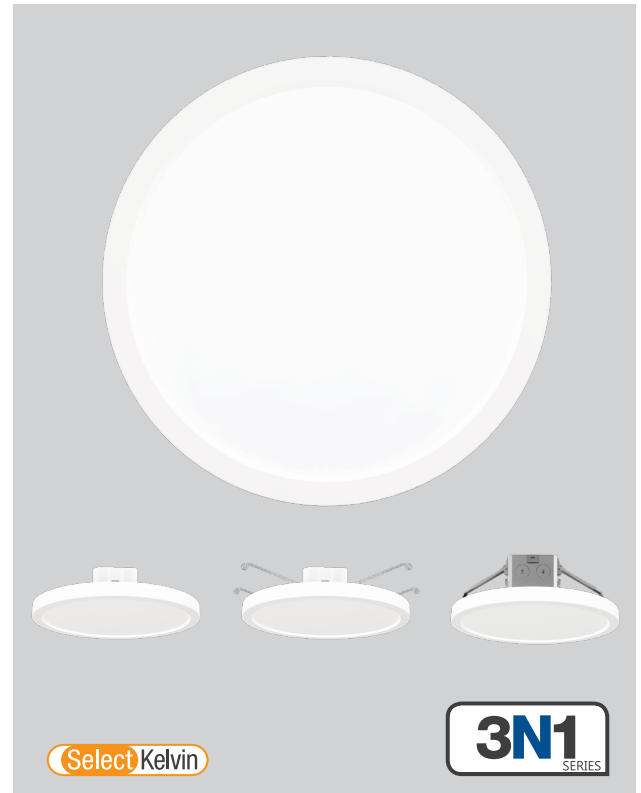

12/18/2020



## BENEFITS

- Installs almost anywhere with Air-Tight, IC and Wet Location ratings
- Three mounting options, with J-box, recessed housing or direct ceiling
- Field selectable CCT
- 0-10V or 120V dimmable

## APPLICATIONS

- Commercial – Offices, Common Areas, Vestibules, Storage Closets
- Residential – Bathrooms, Laundry Rooms, Kitchens, Closets, Garages
- Hospitality – Hallways, Bathrooms, Bedrooms, Storage Rooms

## ORDERING INFORMATION

| Series  | Size  | CRI   | CCT   | Dimming   |
|---|---|---|---|---|
| <input checked="" type="checkbox"/> <b>3N1</b><br>3 N 1 | <input checked="" type="checkbox"/> <b>9</b><br>9" 1250lm | <input checked="" type="checkbox"/> <b>90</b><br>CRI 90 | <input checked="" type="checkbox"/> <b>CCTS</b><br>Selectable CCT 3000/3500/4000K | <input type="checkbox"/> <b>DIM120V</b><br>120V Forward and Reverse Phase Dimming<br><br><input type="checkbox"/> <b>DIM010UNV</b><br>Universal 120-277V, 0-10V dimming |

## LINE DRAWINGS

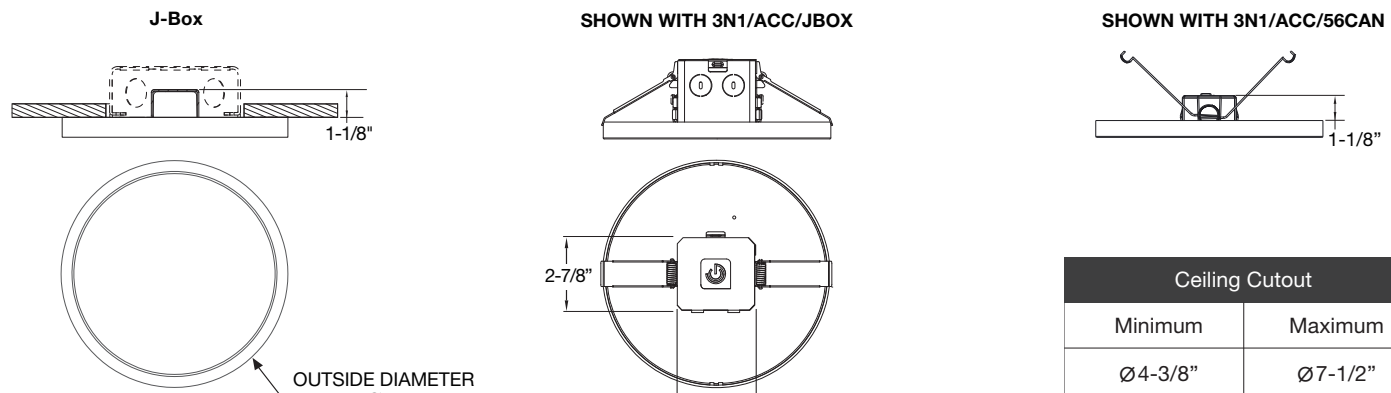

| Ceiling Cutout |         |
|----------------|---------|
| Minimum        | Maximum |
| Ø4-3/8"        | Ø7-1/2" |

# 3N1 9" SURFACE MOUNT

## INSTALLATION METHODS

Junction Box Mount

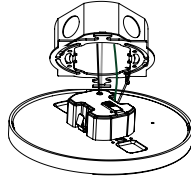

5/6" Recessed Housing

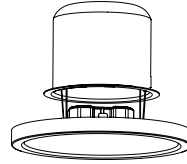

Direct Ceiling Mount

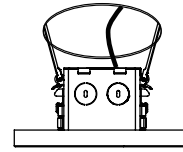

## TECHNICAL INFORMATION

| Dimming    | Input Voltage | Input Frequency | Input Current | Input Power | THD Power | Power Factor |
|------------|---------------|-----------------|---------------|-------------|-----------|--------------|
| DIM120V    | 120V          | 50 / 60Hz       | 0.127A max    | 16.5W       | <20%      | >0.9         |
| DIM010VUNV | 120V          | 50 / 60Hz       | 0.125A max    | 16.5W       | <20%      | >0.9         |
|            | 277V          |                 | 0.062A max    |             |           |              |

## PHOTOMETRY

3N1/9/90/CCTS/DIM120V (3500K Selected)

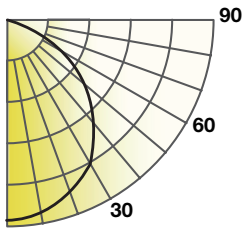

Lumens: 1,314 lm  
 CBCP: 454 cd  
 Power: 16.5 W  
 Efficacy: 80 lm/W  
 CRI: 90+  
 Spacing Criteria: 1.26  
 Beam Angle: 113°

| Candlepower Distribution |              |
|--------------------------|--------------|
| Angle (°)                | Average (cd) |
| 10                       | 453          |
| 20                       | 425          |
| 30                       | 388          |
| 40                       | 337          |
| 50                       | 276          |
| 60                       | 201          |
| 70                       | 124          |
| 80                       | 52           |
| 90                       | 0            |

| Initial Footcandles |    |               |
|---------------------|----|---------------|
| Height (ft)         | Fc | Diameter (ft) |
| 8                   | 11 | 24.4          |
| 10                  | 7  | 30.4          |
| 12                  | 5  | 36.5          |
| 14                  | 3  | 42.6          |
| 16                  | 3  | 48.7          |

| Zonal Lumen Summary |        |          |
|---------------------|--------|----------|
| Zone                | Lumens | %Fixture |
| 0-30                | 355    | 27%      |
| 0-40                | 583    | 45%      |
| 0-60                | 1,033  | 79%      |
| 0-90                | 1,314  | 100%     |

3N1/9/90/CCTS//DIM010UNV (3500K Selected)

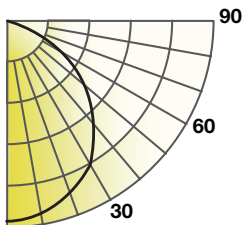

Lumens: 1,277 lm  
 CBCP: 440 cd  
 Power: 15.2 W  
 Efficacy: 84 lm/W  
 CRI: 90+  
 Spacing Criteria: 1.28  
 Beam Angle: 114°

| Candlepower Distribution |              |
|--------------------------|--------------|
| Angle (°)                | Average (cd) |
| 10                       | 439          |
| 20                       | 412          |
| 30                       | 377          |
| 40                       | 328          |
| 50                       | 267          |
| 60                       | 196          |
| 70                       | 122          |
| 80                       | 52           |
| 90                       | 0            |

| Initial Footcandles |    |               |
|---------------------|----|---------------|
| Height (ft)         | Fc | Diameter (ft) |
| 8                   | 10 | 24.8          |
| 10                  | 7  | 31.0          |
| 12                  | 5  | 37.2          |
| 14                  | 3  | 43.4          |
| 16                  | 3  | 49.6          |

| Zonal Lumen Summary |        |          |
|---------------------|--------|----------|
| Zone                | Lumens | %Fixture |
| 0-30                | 344    | 27%      |
| 0-40                | 566    | 45%      |
| 0-60                | 1,004  | 79%      |
| 0-90                | 1,277  | 100%     |







# 3N1 9" SURFACE MOUNT

## NOMINAL PERFORMANCE

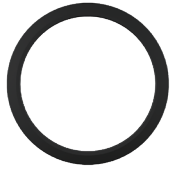
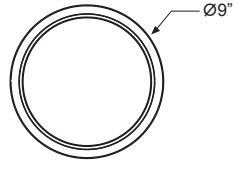
| 3N1/9/90/CCTS/DIM/xxxx |              |       |              |       |              |       |
|------------------------|--------------|-------|--------------|-------|--------------|-------|
| CCT                    | 3000K        |       | 3500K        |       | 4000K        |       |
| Dimming                | 120V Dimming | 0-10V | 120V Dimming | 0-10V | 120V Dimming | 0-10V |
| Output                 | 15.9W        | 16.2W | 16.5W        | 15.2W | 16.1W        | 15.4W |
| Lumens                 | 1,278        | 1,206 | 1,314        | 1,277 | 1,333        | 1,285 |
| LPW                    | 80           | 75    | 80           | 84    | 83           | 84    |

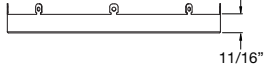
## ACCESSORY ORDERING INFORMATION

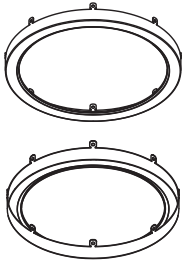
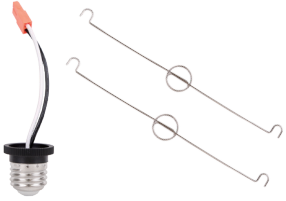
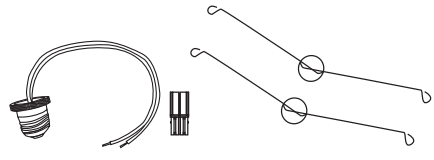
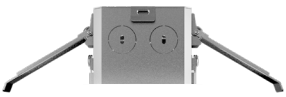
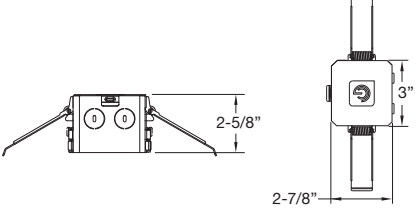
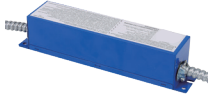
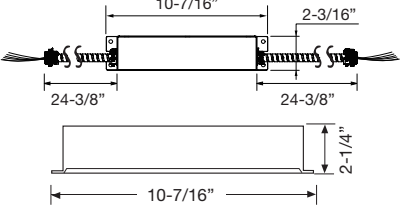
| Product | Model         | Description   | Pictures   | Dimension   |
|---------|---------------|---|--|---|
| 35475   | 3N1/TRM/9/BL  | 9" 3N1 - Black Trim   |     |    |
| 35476   | 3N1/TRM/9/BZ  | 9" 3N1 - Bronze Trim  |    |   |
| 35477   | 3N1/TRM/9/BN  | 9" 3N1 - Brushed Nickel Trim  |   |  |
| 35479   | 3N1/ACC/56CAN | 5-6" Can Installation Accessories   |  |  |
| 35480   | 3N1/ACC/JBOX  | Direct Mount Accessory J-Box  |  |  |
| 98003   | 23EMDRIVER    | California Title 20 Compliant 23W Emergency LED Driver (Field Installation) |  |  |