

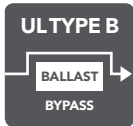





LED HIGH OUTPUT A LAMPS 360° OMNI DIRECTIONAL DESIGN

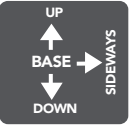

 120-277V VOLTAGE	 ULTYPE B BALLAST BYPASS INSTALL METHOD	 E26/EX39 MEDIUM & MOGUL BASE	 -40°F TO 104°F OPERATING TEMP	 UP BASE DOWN / SIDEWAYS MOUNTING	 ENCLOSED FIXTURES	 80+ CRI	 L70 50,000 RATED LIFE	 IP64 RATED INGRESS PROTECTION	 5 YEAR WARRANTY
--	--	---	--	--	---	---	--	--	---

A21 & A23 High Output Lamps

safe for use in enclosed fixtures



LED-8018M

- Frosted design to reduce glare
- 360° light output for optimal performance
- 14W, 20W, 25W and 35W replacing up to 175W HID & 300W incandescent
- Available in 3000K, 4000K and 5000K color temperatures
- Pretested & potted drivers are burnt in 3x prior to shipping and protected against vibration and moisture
- Expertly engineered to work efficiently in enclosed fixtures & damp environments
- Protected against insects and dust
- 120-277 Non-Dimmable (other than 8017-G2-DIM)

PART #	REPLACES (Incandescent)	REPLACES (HID)	WATTAGE	LUMENS	CCT (K)	BASE	ENERGY STAR	DLC PRODUCT CODE
LED-8015E50-G2	Up to 100W	Up to 70W	14W	1960	5000K	E26	✓	N/A
LED-8017E50-G2	Up to 150W	Up to 100W	20W	2760	5000K	E26	✓	N/A
LED-8017E50-G2-DIM	Up to 150W	Up to 100W	20W	2760	5000K	E26	✓	N/A
LED-8018E50-G2	Up to 200W	Up to 150W	25W	3575	5000K	E26	✓	N/A
LED-8018M50-G2	Up to 200W	Up to 150W	25W	3575	5000K	EX39	N/A	PL3PUZI7KO7Y
LED-8019M50-G2	Up to 300W	Up to 175W	35W	4690	5000K	EX39	N/A	PLGAMPK6VXAH

*LED-8017-DIM available in March 2020



LED HIGH OUTPUT A LAMPS 360° OMNI DIRECTIONAL DESIGN

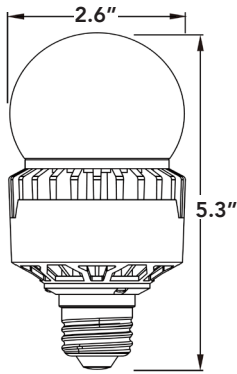

LED-8015E

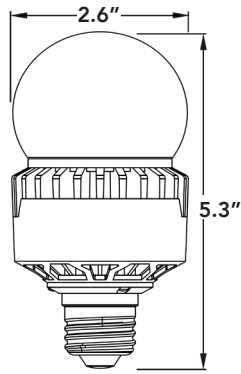

LED-8017E

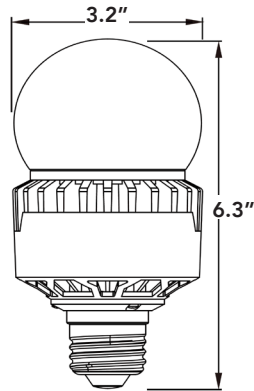

LED-8018E

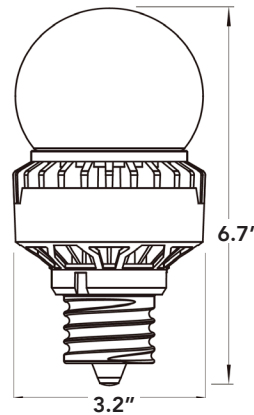

LED-8018M

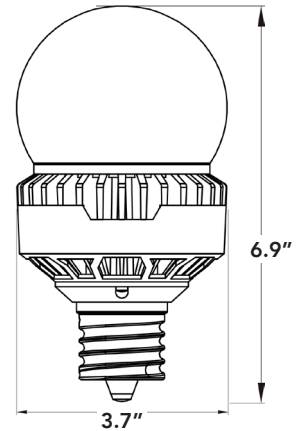

LED-8019M

ORDERING GUIDE

PART #	UPC	REPLACES (INC)	REPLACES (HID)	WATTAGE	LUMENS	CCT (K)	BASE	ENERGY STAR	DLC CODES
LED-8015E30-G2	844006035969	100W	70W	14W	1792	3000K	E26	•	N/A
LED-8015E40-G2	844006035976	100W	70W	14W	1918	4000K	E26	•	N/A
LED-8015E50-G2	844006035983	100W	70W	14W	1960	5000K	E26	•	N/A
LED-8017E30-G2	844006035990	150W	100W	20W	2540	3000K	E26	•	N/A
LED-8017E40-G2	844006036003	150W	100W	20W	2720	4000K	E26	•	N/A
LED-8017E50-G2	844006036010	150W	100W	20W	2760	5000K	E26	•	N/A
LED-8017E30-G2-DIM	844006052218	150W	100W	20W	2540	3000K	E26	•	N/A
LED-8017E40-G2-DIM	844006052225	150W	100W	20W	2720	4000K	E26	•	N/A
LED-8017E50-G2-DIM	844006052232	150W	100W	20W	2760	5000K	E26	•	N/A
LED-8018E30-G2	844006036027	200W	150W	25W	3375	3000K	E26	•	N/A
LED-8018E40-G2	844006036034	200W	150W	25W	3525	4000K	E26	•	N/A
LED-8018E50-G2	844006036041	200W	150W	25W	3575	5000K	E26	•	N/A
LED-8018M30-G2	844006036058	200W	150W	25W	3375	3000K	EX39	N/A	PLYYO2FRL1TZ
LED-8018M40-G2	844006036065	200W	150W	25W	3525	4000K	EX39	N/A	PLJ38NJP57SW
LED-8018M50-G2	844006036072	200W	150W	25W	3575	5000K	EX39	N/A	PL3PUZI7KO7Y
LED-8019M30-G2	844006036089	300W	175W	35W	4400	3000K	EX39	N/A	PLFD10SWG40S
LED-8019M40-G2	844006036096	300W	175W	35W	4400	4000K	EX39	N/A	PLZ89EO4KDCG
LED-8019M50-G2	844006036102	300W	175W	35W	4690	5000K	EX39	N/A	PLGAMPK6VXAH

