

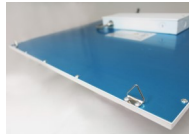

0 ~ 10v



Clips located at the back of the panel

## DIMENSIONS:

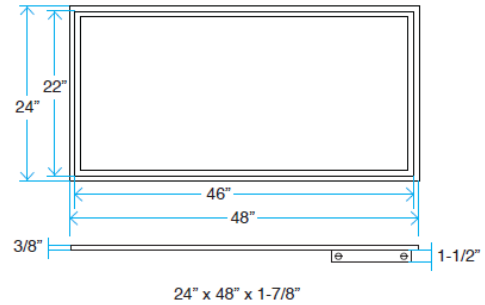

- LP-2X4-60W-35K-D
- LP-2X4-60W-40K-D
- LP-2X4-60W-50K-D

## LED Panel Light (2X4)

Superb brightness that saves 75% energy compared with traditional panel lights.

### ELECTRICAL SPECIFICATIONS:

- Power efficiency: >0.87
- Power factor: >0.9
- High efficiency: 85lm/w
- Input voltage: AC100V~277V
- Output voltage: 36VDC
- LED type: 4014SMD LM80
- Color rendering index: Ra > 82
- With external constant current power supply

### LIGHTING SPECIFICATIONS:

- Dimmable 0 ~ 10v Dimming
- Current (mA): 1500mA
- Frequency range: 50Hz~60Hz
- Total harmonic distortion: ≤15 %
- Color temperature: 3500K, 4000K, 5000K

### HOUSING SPECIFICATIONS:

- Material: AL+PMMA+PS
- Working temperature: ~ 20 ~ 45 °C
- Storage temperature: ~ 25 ~ 65 °C
- IP grade: IP20
- Working life-span: 5,0000H

## ACCESSORIES:



LP-SRFC-2X4



LP-SSPD-2X4



LP-SAFETYCLIP

MODEL NO.	POWER	LUMENS	SMD4014 LEDs	CCT
LP-2X4-60W-35K-D	60W	5100	384	W3500K
LP-2X4-60W-40K-D	60W	5100	384	N3985K
LP-2X4-60W-50K-D	60W	5100	384	D5028K

LP-SRFC-2X4	Surface mounting kit for 2x4, aluminum structure, 4 pcs + screw kit
LP-SSPD-2X4	Suspending wire rope for 2x4, 3 wire pcs
LP-SAFETYCLIP	Earthquake clip for panel, 1pc

## FEATURES:

- Soft and wide light emitting
- Ultra slim, unlimited design and various dimensions are available
- No infrared rays, no ultraviolet radiation, no thermal effect
- Special circuit design, avoided the single broken LED influence problem
- High efficiency constant current drive system, with heat protection system, can work under unstable voltage
- Instant start, no flickering, no humming, no RF interference

## WARRANTY:

- Five-year warranty

## CERTIFICATIONS:



- UL listed / LM80 rated
- DLC standard



LP-2X4-60W-35K-D  
 LP-2X4-60W-40K-D  
 LP-2X4-60W-50K-D

## LED Panel Light (2x4)

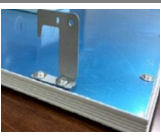

MODEL NO.	DESCRIPTION	QUANTITY	INSTALLATION
LP-SRFC-2X4	Surface mounting kit for 1x4, aluminum structure	4pcs + screw kit	
LP-SSPD-2X4	Suspending wire rope for 1x4	3 wire pcs	
LP-SAFETYCLIP	Earthquake clip for panel	1pc	

### System Connection Diagram:

#### A. Wiring of the panel light with 0-10V dimmable driver

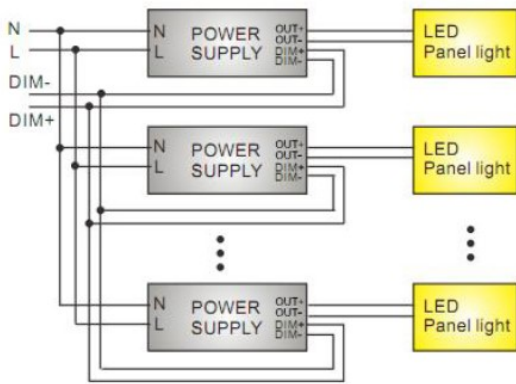

### Structure:

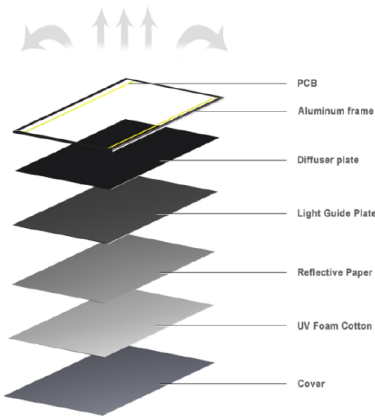

### Package:

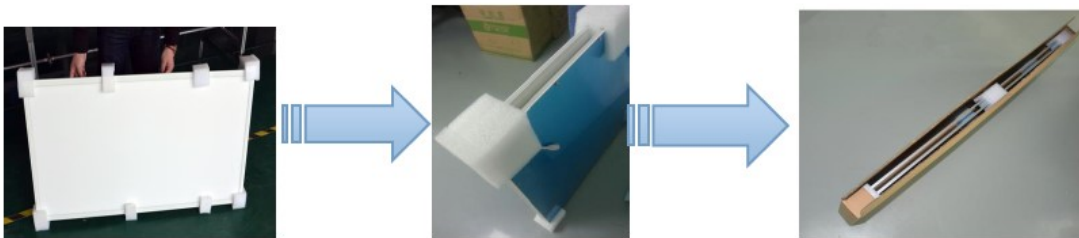

PART NO.	PACKAGE DIMENSION	N.W.	G.W.
2x2 FT 24"X24"X.35"	26"X 4.3" X 26" 2pcs/carton	4.7 kg/pc	9.8kg/ctn
1X4 FT 12"X48"X.35"	50" X 4.3" X 14" 2pcs/carton	4.7 kg/pc	11.1kg/ctn
2X4 FT 24"X48".35"	50" X 4.3" X 26" 2pcs/carton	8.9kg/pc	18.6/ctn

### Warning:

- Please use the product within the specified range of voltage.
- Please follow the correct installation steps to install the product, and do not touch when it is working.
- Please turn power off when installing and removing the products to avoid risk of electric shock.
- Please install the panel in the correct sized fixture.
- Do not look directly at LED light source for a long time.



LP-2X4-60W-35K-D  
 LP-2X4-60W-40K-D  
 LP-2X4-60W-50K-D

**LED Panel Light (2x4)**

**Spectral Power Distribution**

Spectral Power Distribution and Chromaticity Diagram:

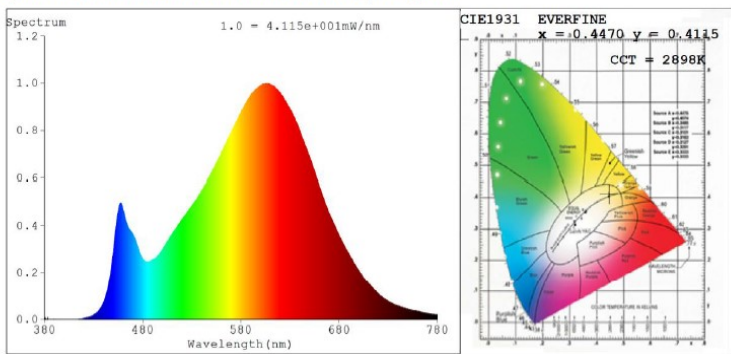

**Photometric Data**

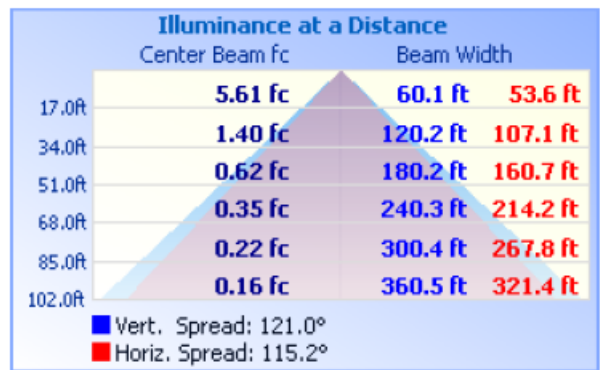

**Illuminance Plots**

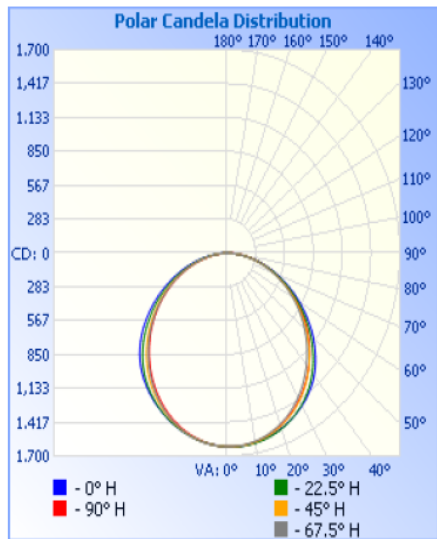

**ISOLUX DIAGRAM**

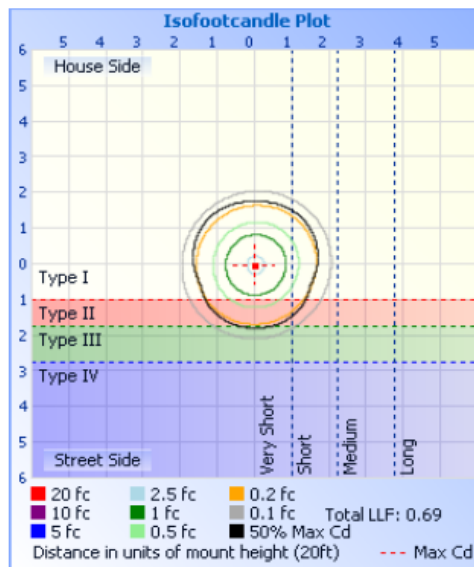

**ISOCANDELA DIAGRAM**

